

9124729 SERVICE MANUAL MODULAR CONVENIENCE COUNTER MCC HOT USA



- NOTICE -

This service manual is prepared to be used by trained Service Technicians and should not be used by those not properly qualified. If you have attended a training for this product, you may be qualified to Perform all repair procedures, replacements and adjustments described in this service manual.

The information presented in this document is only valid for standard hot modular convenience counters, (MCC) configurations and is not intended to be all encompassing. The individual specifications may differ.

Procedures for which you do not have the necessary tools, instruments or skills should not be performed by you.

Technical data and specifications mentioned in this manual are subject to amendment without prior notice.

**Reproduction of this service manual,
Without the express written consent of Fri-Jado,
Is prohibited.**

Version	Issue date	Remarks
	dd/mm/yy	
Rev 1	01-06-2020	First release based on Self Serve
Rev 2	03-05-2021	Adding Full Serve
Rev 3	01-06-2021	Adjusting controller hot
Rev 4	01-04-2022	Addition multiple Shelves version, electrical schematics revision
Rev 5	07-2022	Change to EU and USA manual
		ERC alternatives replacement
		Adding two and four level
		Adding FS element replacement
Rev 6	09-2023	Adding parts numbers (Front doors)
Rev 7	22-03-2024	Several remarks updated

KEEP THIS USER MANUAL FOR FUTURE USE

© 2023 Fri-Jado B.V., Oud Gastel, The Netherlands.

We refer to our General Terms and Conditions for Sales and Delivery that are available upon request.

The manufacturer does not accept any liability for damage or injury caused by failing to adhere to these regulations or by not observing the usual caution or care in actions, operation, maintenance or repair activities, even if not explicitly described in this manual.

As a result of constant commitment to improvement, it may happen that your unit deviates in detail from what is described in this manual. For this reason, the given instructions are only a guideline for the installation, use, maintenance and repair of the unit referred to in this manual.

This manual has been composed with the utmost care. The manufacturer shall, however, not be held responsible for any mistakes in this manual nor for any consequences thereof. All rights are reserved and nothing in this manual may be reproduced and/or made public in any way.

Modifications:

In case of unauthorized modifications in or on the unit, every liability on the part of the manufacturer becomes null and void.

Index

1.0 Introduction	5
2.0 Detailed description	8
3.0 Unpacking	11
4.0 Installation	13
4.1 Accessories	17
5.0 MCC Drop-in	19
6.0 Installation Front door section (first version)	28
6.1 Installation Front door section (Second version)	34
7.0 Operation MCC Hot	42
7.1 Operation MCC Hot <access controller>	43
7.2 Operation <access controller>	44
8.0 Service instruction controller replacement	45
8.2 Parameter setting Hot Self Serve	48
8.3 Parameter setting Hot Full Serve	49
9.0 Maintenance	50
10.0 Trouble Shooting	51
11.0 Trouble Shooting Symptoms and causes	53
11.1 Trouble Shooting Analytical description	54
12.0 Replacement and Adjustments	56
12.1 Hot Full serve element replacement	68
13.0 Technical Specifications MCC Hot - 2 (Full Serve) US	72
13.1 MCC 90 Drop-in Dimensions Self Serve	73
13.2 Technical Specifications MCC Hot - 2 (Self Serve) US	74
13.3 MCC Hot Drop-in Specifications Self Serve	75
13.4 Technical Specifications MCC Hot - 3 (Full Serve) US	76
13.5 Technical Specifications MCC Hot - 3 (Self Serve) US	77
13.6 Technical Specifications MCC Hot (Self Serve) Humidified US	78
13.7 Technical Specifications MCC Hot - 4 (Full Serve) US	79
13.8 Technical Specifications MCC Hot - 4 (Self Serve) Humidified US	80
13.9 Explanation difference in levels and shelves	81

14.0 Exploded view MCC Hot 2 Level	82
14.1 Exploded view MCC Hot 2 Level	84
14.2 Exploded view MCC Hot 3 Level (Self Serve)	86
14.3 Exploded view MCC Hot 3 Level(Self Serve)	88
14.4 Exploded view MCC Hot 3 Level (Self Serve)	90
14.5 Exploded view MCC Hot Structure X level (Full Serve version 1)	92
14.6 Exploded view MCC Hot Structure X level	94
14.7 Exploded view MCC Hot 4 Level	96
14.8 Exploded view MCC Hot Electrical	98
14.9 Exploded view MCC Hot Electrical (Humidified)	100
14.9 Exploded view MCC Hot Electrical (Humidified)	101
15.0 Electrical schematic MCC Hot (Self Serve, One phase)	102
15.0.1 Electrical wiring MCC Hot (Self Serve, One phase)	103
15.0.2 Electrical schematic MCC Hot (Self Serve)	104
15.0.3 Electrical wiring MCC Hot (Self Serve)	105
15.1.0 Electrical schematic MCC Hot (Self Serve) (One phase time relay)	106
15.1.1 Electrical wiring MCC Hot (Self Serve) (One phase and time relay)	107
15.2.1 Electrical schematic MCC Hot (Self Serve, Three phase)	108
15.2.2 Electrical wiring MCC Hot (Self Serve, Three phase)	109
15.2.3 Electrical wiring MCC Hot (Self Serve, Three phase)	110
15.3 Circuit Diagram MCC Hot (Full Serve first version)	112
15.4 Electrical wiring MCC Hot (Full Serve first version)	113
15.5 Circuit Diagram MCC Hot (Full Serve second version)	114
15.6 Circuit Diagram MCC Hot (Full Serve first second version)	115

1.0 Introduction

1.1 General

This manual is intended for trained technicians, performing repairs on the MCC Hot. The features and controls are being described, along with directions for the safest and most efficient way to service these counters. All pictograms, symbols and drawings in this manual apply to all available MCC models.

1.2 Identification of the unit

The identification plate can be found on the outside of the machine, and contains the following data:

- Name of the supplier or the manufacturer
- Serial number
- Voltage
- Power consumption
- Model
- Year of construction
- Frequency

1.3 Pictograms and symbols

In this manual, the following pictograms and symbols are used:

WARNING symbols:



WARNING
Possible physical injury or serious damage to the unit,



WARNING
Risk of Fire.



WARNING
Hazardous electrical voltage.



WARNING
Danger of getting injured by hot surfaces.

SAFETY symbols:



SAFETY
Wear safety gloves for installation and dismantling.



SAFETY
Wear eye protection.



SAFETY
ALWAYS Remove power plug from main outlet before working on the unit.



Disposal
According local regulations



SAFETY
Clean Hands and/or Tools

Suggestions and recommendations.



Notification
Take care off:



Reading
Instructions referred to read



Recycling symbol.



Part of manual
Still under construction



Minimum room floor area.



Cleaning
On regularly interval



Pictures or photos
Still to be added

1.4.1 General regulations

The technician, working on the unit will be fully responsible for abiding the locally prevailing safety rules and regulations.

Technical activities must be performed by qualified and authorized persons only.



Before working on any electrical part, or dismantling the unit by means of using a screwdriver, **ALWAYS REMOVE** the power plug from the main outlet.

Anyone performing technical repairs, replacements or adjustments on or with this unit must be familiar with the contents of this service manual and carefully follow all guidelines and instructions.

Never change the order of the steps to be performed.

The pictograms, labels, instructions and warning signs attached to the unit, are part of the safety measures. They may never be covered or removed, and have to be clearly visible during the entire lifetime of the unit.

Immediately repair or replace damaged or illegible pictograms, warnings and instructions.



Notes:



- To avoid short-circuiting, never clean the unit using a water hose.
For detailed cleaning instructions, please refer to MCC user manual.



- The shelves, glass and back of the hot unit can get hot.



- All units must be cleaned regularly to ensure proper functioning.



- Do not store explosive substances;
such as aerosol cans with flammable propellant in this appliance.

1.4.2 Moving

- Before moving the unit, first switch off the mains switch and disconnect power by pulling the plug from the wall socket.
- Remove pans containing a liquid product from the unit.
- Always keep the unit in upright position.

1.4.3 Outdoor use restrictions

WARNING

To avoid short-circuiting, the units may not be used outdoors nor in a rainy or very moist environment.

1.5 Hygiene



WARNING

Immediately remove products in damaged packaging from the equipment and destroy the products.

Clean all components that have come in contact with products from damaged Packaging.

The quality of a fresh product always depends on hygiene.
It is essential that products are packaged immediately after preparation.

Prevent fresh raw vegetables or already prepared, cooled products from coming into contact with raw meat products to avoid transmitting salmonella.



First thoroughly clean hands and/or tools that have touched raw meat and/or meat juices.

For detailed cleaning instructions, please refer to MCC user manual.

1.6 Service and technical support

The electrical schematics of the unit are included at the end of this manual.
In case of malfunctions which are not fixable by you, you can contact Fri-Jado.
Make sure you have the following data available:

- Model.
- Serial number.

This data can be found on the identification plate.

1.7 Storage

If the unit will not be used temporarily, and will be stored, follow these instructions:

- Clean the unit thoroughly.
- Wrap the unit from getting dusty.
- Store the unit in a dry, non-condensing environment.
- Ensure good ventilation.

1.8 Disposal

Dispose of the machine, any components or lubricants removed from it safely in accordance with all local and national safety and environment requirements.



2.0 Detailed description

2.1 Technical description Self Serve

Panels are made of galvanized steel plating, stainless steel and/or aluminum.
 Some of the visible internal and external parts have been provided with a powder coating.
 Glass used is tempered.
 Unit can be moved by means of a pallet truck.

Product contact parts are made of stainless steel AISI 304 or AISI 430 and tempered glass.

2.2 Hot units Self Serve: (Patented Hot Blanket Holding technology)

Heating in hot self-serve units is achieved by means of heated shelves in combination with an hot-air curtain per shelf. This air curtain isolates the hot air inside the unit from the ambient air.

Hot serve over units have a single heat source in the base of each shelf and use fans to distribute the heat throughout the cabinet.

An electronic thermostat controls the temperature.
 The electronic thermostat has been pre-set at the factory.

This value can be changed for self-serve models between 40 °C and 70 °C (104 °F and 158 °F) and for full serve models between 40 °C and 85 °C (104 °F and 194 °F).

One LED-module per level provides lighting of the products.
 The LED-lighting and the heating are switched on and off separately, In the future Lightning and heating can be switched on simultaneously.

Hot Air flow Self Serve



2.3 Intended use

Self-serve models have been designed solely to keep packaged products warm and to display them.

Full Serve models can be used for unpacked foodstuff as well.



Any other use will not be regarded as intended use.

The manufacturer accepts no liability whatsoever for loss or injury caused by failing to strictly adhere to the safety guidelines and instructions in this manual or due to carelessness during installation, use, maintenance and repair of the unit referred to in this manual and any of its Accessories.

Use the unit in perfect technical condition only.

2.6 Technical description Full Serve Hot Humidified

The MCC Hot FS is a multilevel serve over heated display cabinet intended for hot presentation of food products.

A heating element and an array of fans are located in the base of the unit and circulate hot air throughout the cabinet, creating uniform holding conditions.

Any air in- and outlet openings should be kept clear. A digital controller is installed to regulate the temperature inside the cabinet.

A water tray is present underneath the base deck which can be used to increase the humidity levels inside the cabinet, hereby increasing the shelf life of delicate products.

To make sure the cabinet is installed, operated and serviced in a safe manner, the instructions provided by the manufacturer should be adhered to at all times.

The cabinets can also be supplied with or without under frame to be installed into an existing counter top.

Heating in hot full-serve units is achieved by means of a finned heating element in combination with hot-air blowers. The blower fans suck air on the intake side, blowing this air along the heating element causes the air to heat up.

To prevent products from drying, humidification is applied by means of a water tray underneath the hot air flow. Hot air holds more moisture. The moist hot air is blown into the unit, creating a higher humidity inside the “closed” unit.

Serve over models can be fitted with an optional humidification system in the form of a passive water tray or an independently controlled boiler type system (which requires a permanent water supply and drain).

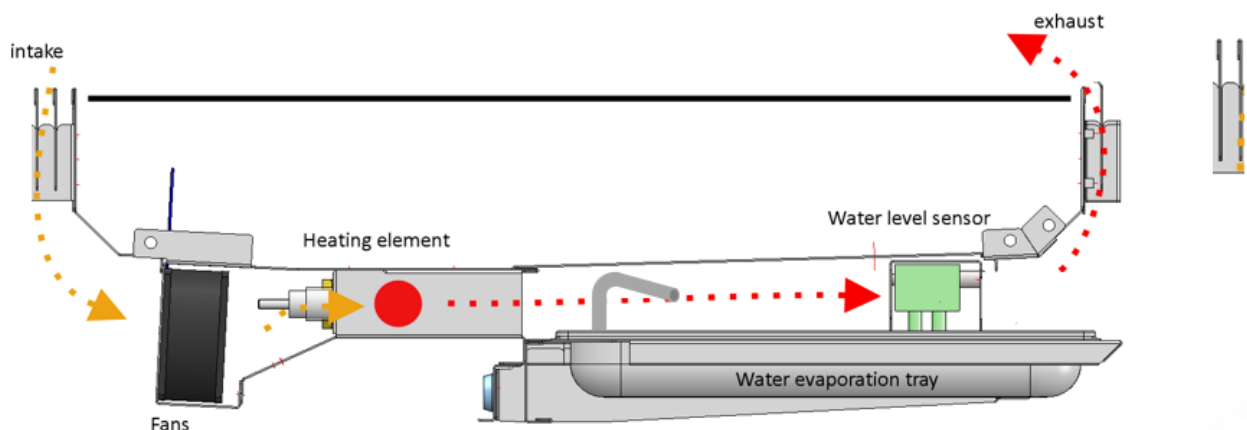

Filling of the water tray can be done either by hand, or automatically. For the automatic filling system, an additional electrical box is implemented which controls the filling process.

Hand filling system

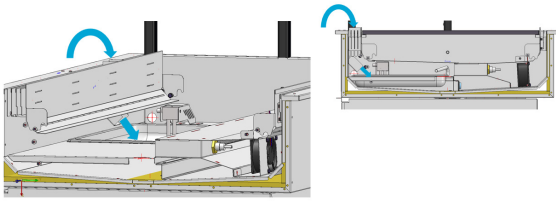

Automatic filling system

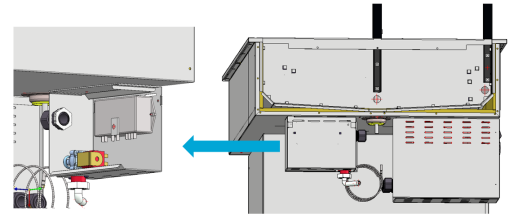

Complete build up structure of the MCC hot Full serve first version.

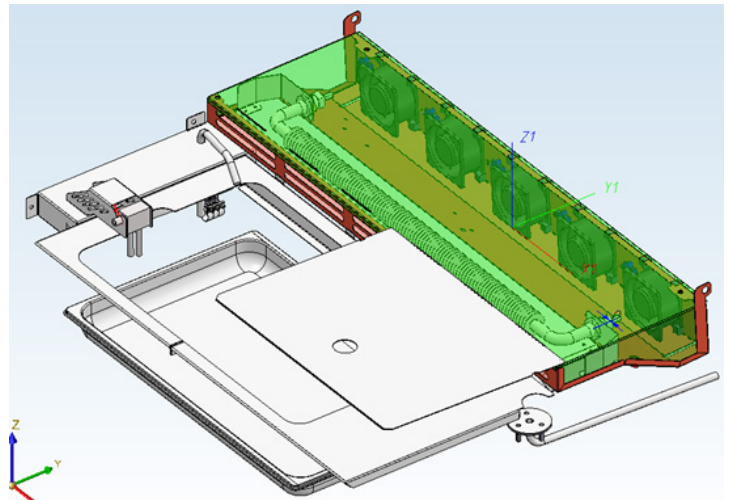
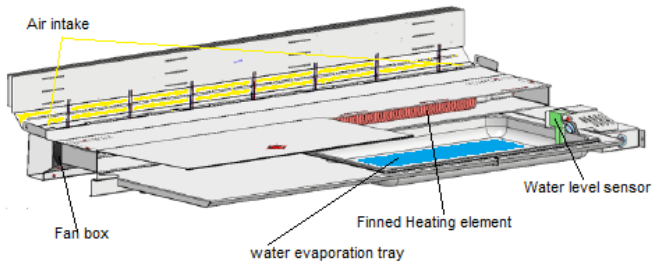

Second version (turnable heating compartment)

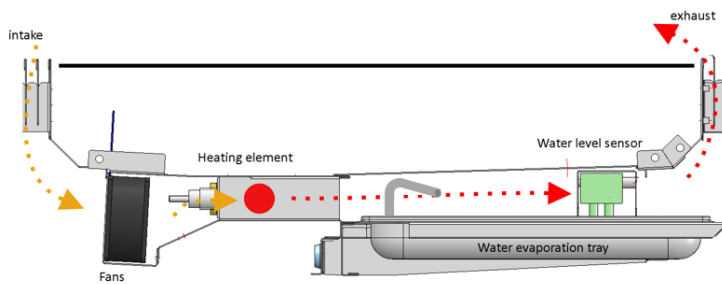
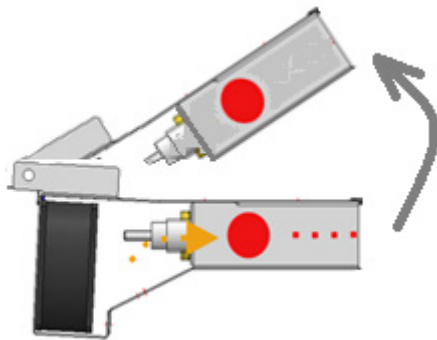

Hot air flow Full Serve



3.0 Unpacking

3.0 Start to unpack



All packing materials used for this unit are suited for recycling.

Before and during unpacking, check the state of the unit. In case of damage, photograph the damage, store the packing material, and contact the transporter as soon as possible but at the latest within fifteen working days after receiving the goods.

3.1 Unpacking the unit

The MCC is placed inside a crate during transport, take the following steps to unpack.

1. Remove the top crate pane and foam.
2. Remove the front and rear boards.
3. Remove both side boards.
4. Lift the unit from the support beams using a pallet truck or forklift.
5. Remove the supporting beams.
6. Observe the safety and warning signs.

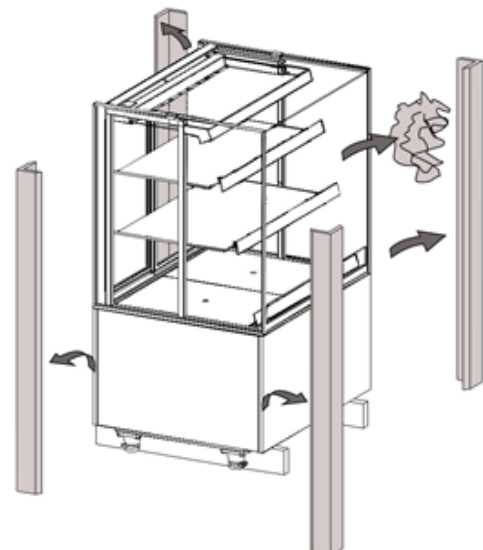
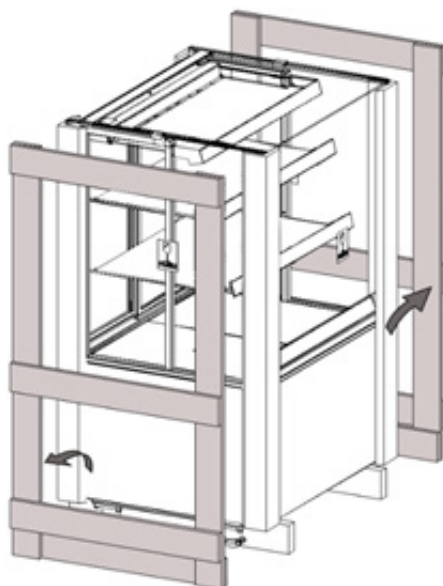
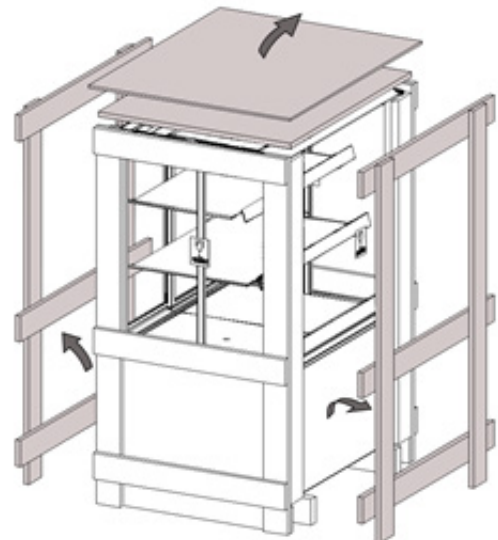
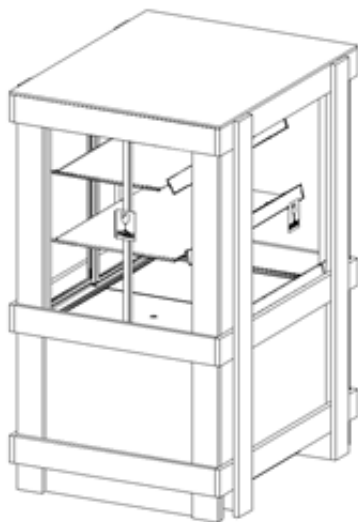



Refer to User manual for installation procedure

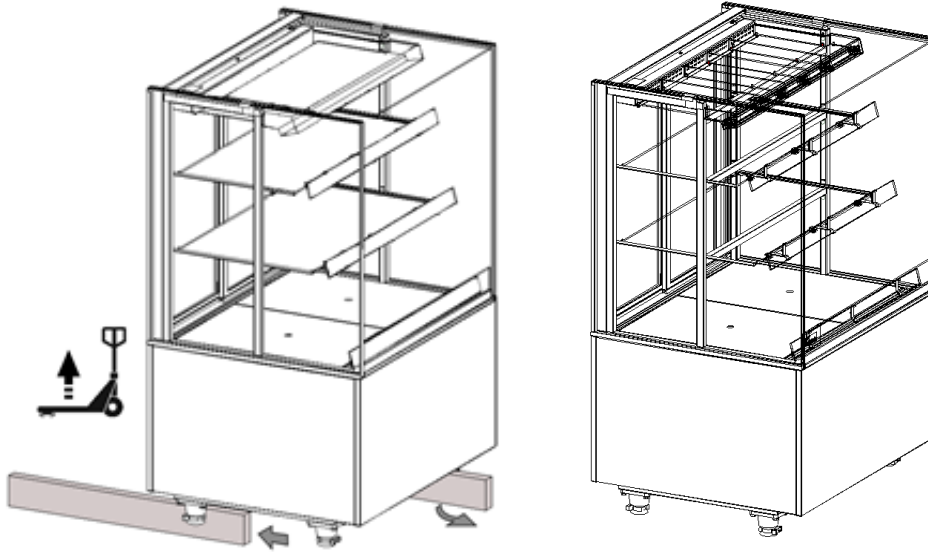

4.0 Installation

4.0.0 Installation and positioning



WARNING

Position the unit on a flat and horizontal surface.

A temporally inclined plane of maximum 5° is allowed.

- Place the unit level on a sufficiently sturdy floor.
- Keep the weight of the unit in mind.
- Use a level-ling instrument to level the unit by adjusting the unit's legs.
- Be sure that the personnel have sufficient room to work with the unit.
- Keep a distance of at least 150 mm (6 inch) between the back wall and the unit.
- Do not position a unit near a doorway, a ventilation device or a refrigerator in order to avoid any negative effects on the unit's operation by a cold airflow.

The unit is designed for a maximum draft of 0.2 m/s (0.65 ft./sec).

- Do not place the unit into direct sunlight.
- Hot units should not be used below 20 °C (68 °F) ambient temperatures and a relative air humidity remains below 60%.
- Keep the plinth free from any obstacles to ensure ventilation.

Hot Unit

The unit is set at 65 °C (149 °F) intake air temperature for the self-service models, and 80 °C (176 °F) for the serve over model.

If required this temperature can be adjusted to some degree.

At a ambient temperature of 20 °C (68 °F) and an initial core temperature of 85 °C (185 °F) these factory settings of the unit's temperature ensure a constant core temperature of at least 63 °C (145.5 °F) for 4 hours.

Switching-on the unit:

- Switch the heating on.
- Preheat the unit for approx. 30 minutes.
- Switch on the lighting.

Loading the unit:

- Only place products that have a core temperature of at least 85 °C (185 °F).
- Only package the hot products in bags or containers that are suitable for this purpose.
- To ensure a good contact with the heated trays, only place a single layer of products.
- The maximum loading height is 50mm (2 inch) below the bottom of the shelf/air guide above.
- The maximum carrying-capacity per shelf is 30 kg/m (66 lbs/m), by equal load.



Warning Electrical shock Hazard

- Grounding instructions:
Only connect the appliance to an alternating current, to a grounded wall socket, with a mains voltage in accordance with the information indicated on the type plate of the appliance.
- It is the consumer's responsibility to make sure the electrical installation conforms with current national and local codes and wiring regulations.
- It is not allowed to use a multi plug or extension cord. Such can result in fire, electrical shock, or personal injury.



Failure to follow these instructions can result in serious injury or in death.

4.1 Applying price rail

Optional price rails for Hot self-serve models can be mounted using the front screws underneath each of the Hot SS shelves. Do not loosen this screws entirely!

Price rails for serve over models can be mounted on the air inlet grill and on the glass shelves.



4.2 Repositioning the glass shelves on Hot FS models



The glass shelves can be positioned at three horizontal levels (I), or one of three angled positions (II and III) by changing the positions of the LED-armature with respect to the rear.

Examples:

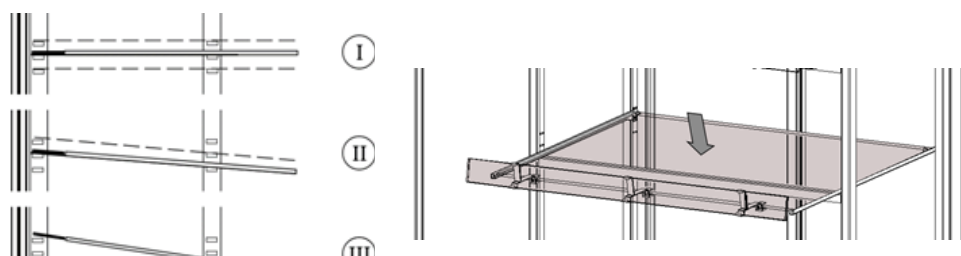

For repositioning details refer to User manual

4.3 Hot SS models



The shelves can be positioned at two angled positions (0° and 3°). Refer to user manual.



Hot FS models

Water connection for automatic fill, Refer to user manual 3.6.1
 Water Manually fill, Refer to user manual 3.6.2

Unit	GN tray size	Max. reservoir water level	Reservoir water level when alarm activates	Max. water volume to add (only when alarm is on!)
MCC-60 H FS	GN 1/2 40mm	2,5L (0.66 gallon)	0,75L (0.19 gallon)	1,75L (0.46 gallon)
MCC-90 H FS	GN 1/1 40mm	5L (1.32 gallon)	1,5L (0.39 gallon)	3,5L (0.92 gallon)
MCC-120 H FS	GN 1/1 40mm	5L (1.32 gallon)	1,5L (0.39 gallon)	3,5L (0.92 gallon)

4.4 Plateau Options

On all MCC models, except the MCC Hot SS, the bottom presentation deck can be set at a variety of horizontal levels.



Refer to user manual

4.5 Solid back option

On request the unit can be ordered having a solid back in stead of sliding doors

4.6 First use

Before starting to use the unit, clean the inside thoroughly with mild detergent and water. After cleaning it wipe it with a cloth moistened with clean water to remove residual detergent, then dry the entire unit.

4.7 Level the unit

Place the unit on a sturdy, flat surface and level the unit by adjusting the unit's legs (max. +15mm).



4.8 Mounting the plinths

Place the rear plinth by attaching it to both rear Adjustable legs using its two clamps.

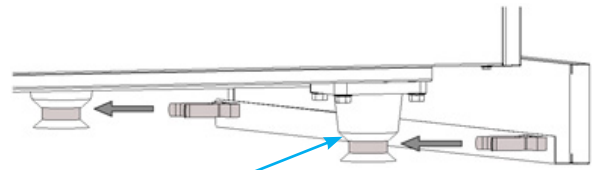

Insert the pegs of both side plinths into the slots of the rear plinth.

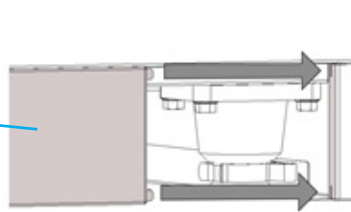
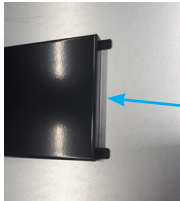
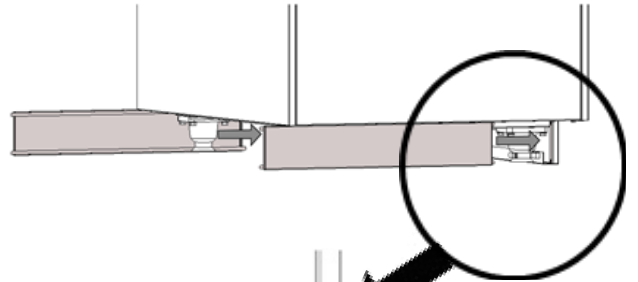



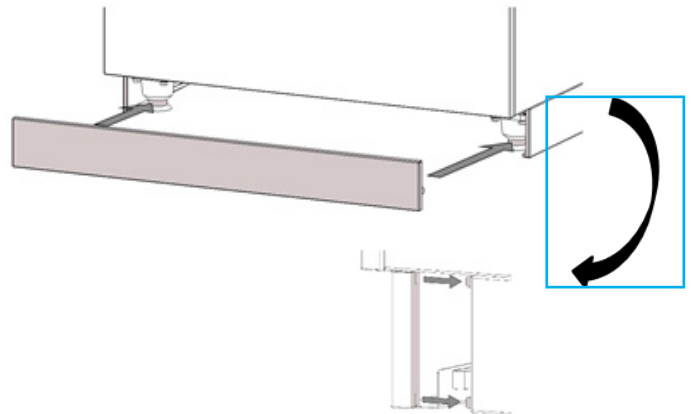



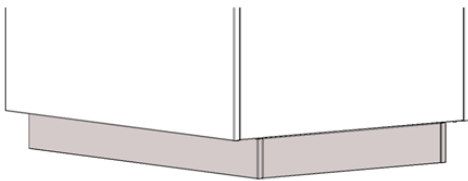



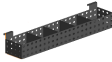

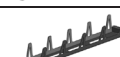

Secure the side plinths by inserting the pegs into the slots of the front plinth, while clamping the front plinth to the front adjustable legs.

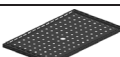
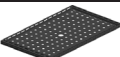
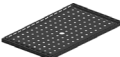
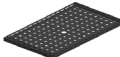
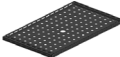
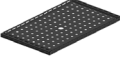
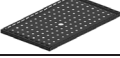
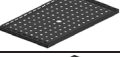
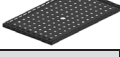

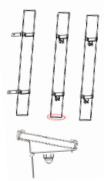



Result

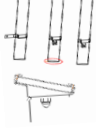
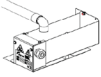

4.1 Accessories

Accessoires	MCC Hot Self Serve	Compatibility		
Condiment holder	9380198	MCC 60/90/120		
Merchandising rack 410 mm - Top Shelf	9384463	MCC 60/90/120		
Merchandising rack 475 mm - Middle Shelf	9384473	MCC 60/90/120		
Merchandising rack 550 mm - Bottom Shelf	9384475	MCC 60/90/120		
Shelf divider 410 mm - Top Shelf	9384505	MCC 60/90/120		
Shelf divider 475 mm - Middle Shelf	9384503	MCC 60/90/120		
Shelf divider 550 mm - Bottom Shelf	9384505	MCC 60/90/120		
Shelf insert 250x410 mm - Top Shelf	9384534	MCC 60		
Shelf insert 250x475 mm - Middle Shelf	9384535	MCC 60		
Shelf insert 250x550 mm - Bottom Shelf	9384536	MCC 60		
Shelf insert 400x410 mm - Top Shelf	9384461	MCC 90		
Shelf insert 400x475 mm - Middle Shelf	9384470	MCC 90		
Shelf insert 400x550 mm - Bottom Shelf	9384471	MCC 90		
Shelf insert 550x410 mm - Top Shelf	9384537	MCC120		
Shelf insert 550x475 mm - Middle Shelf	9384538	MCC120		
Shelf insert 550x550 mm - Bottom Shelf	9384539	MCC120		
Accessoires	MCC Hot Self Serve	MCC Hot Self serve humidified	MCC Hot Full serve	
Price rail set MCC SS 60	9389801			
Price rail set MCC SS 90	9389802			
Price rail set MCC SS 120	9389803			
Price rail set MCC FS 60		9389811	9389811	
Price rail set MCC FS 90		9389812	9389812	
Price rail set MCC FS 120		9389813	9389813	
Bumper MCC 60	9380206	9380206	9380206	
Bumper MCC 90	9380207	9380207	9380207	
Bumper MCC 120	9380205	9380205	9380205	
Castor set	9389851	9389851	9389851	
Total height of MCC + 23 cm				
Accessoires	MCC Cold Self Serve	MCC Cold Self serve with doors	MCC Cold Full serve	
Price rail set MCC 90	9389812	9389812	9389812	

Price rail set MCC 120	9389813	9389813	9389813	
Price rail set MCC 150	9389814	9389814	9389814	
Evaporation tray	9389820	9389820	9389820	
Bumper MCC 90	9380207	9380207	9380207	
Bumper MCC 120	9380205	9380205	9380205	
Bumper MCC 150	9380208	9380208	9380208	
Castor set	9389852	9389852	9389852	
Total height of MCC + 23 cm				

5.0 MCC Drop-in

The MCC Drop in will be delivered, packed in a crate

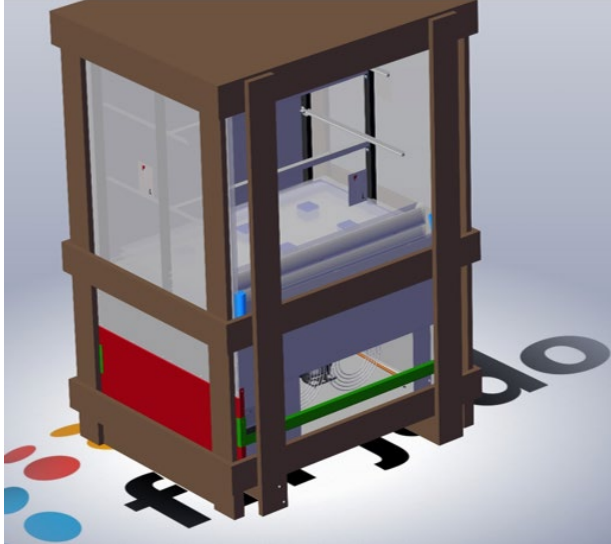

Start unpacking by removing top cover

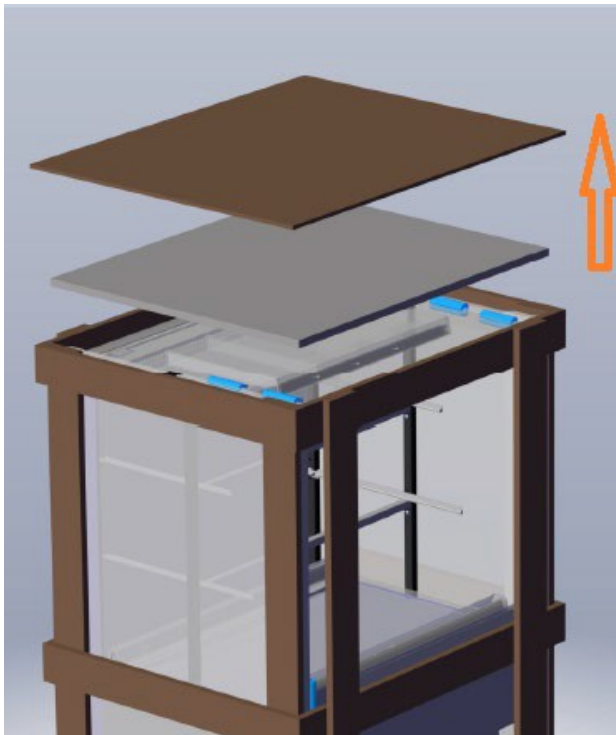

Remove short sides first (Left and Right), by unscrewing them.

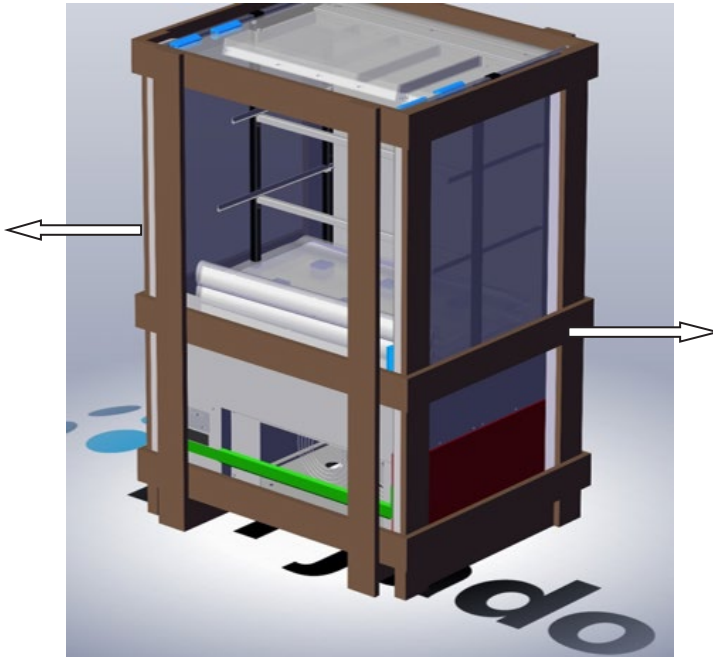

Next, remove front and back panel, they are also screwed onto the support beams under the unit.

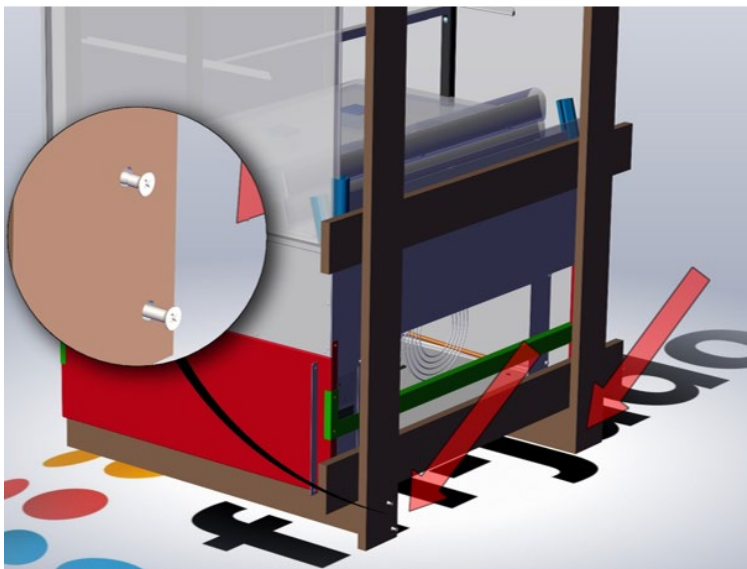

Keep the support beams for further use.

Remove wrapping foil and remove corner pieces EPS foam.

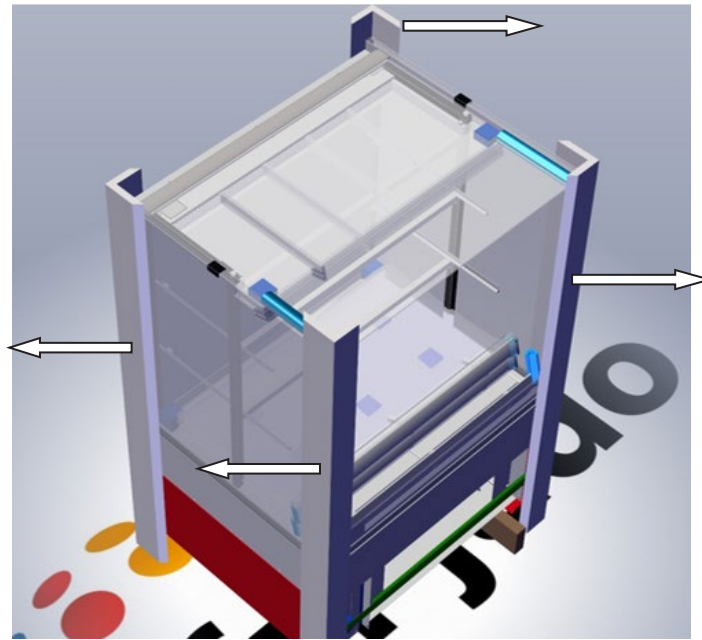

Unit is placed on a metal sub frame for transport purposes. Frame is kept together with metal strip at the front and the back.

Keep strip in place during placing process. Keep wooden support beams for further usage.

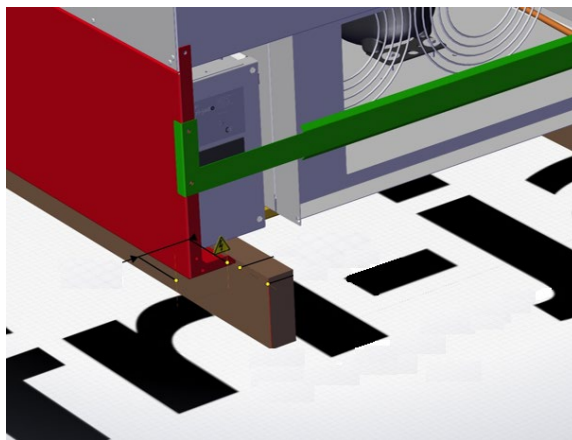

After lowering the cabinet into the cut-out in the counter top:
Remove tie-wrap which is holding the power cord.

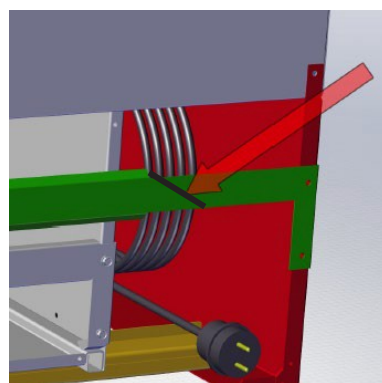

Remove foam which holds the electrical box

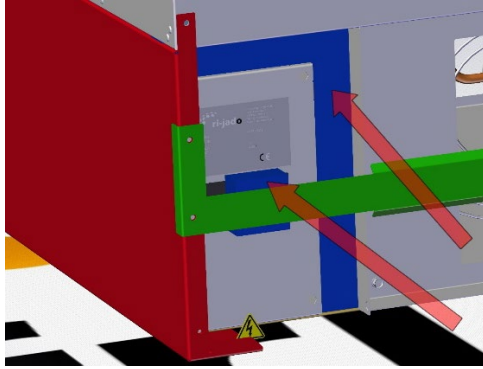

Remove documents and glass shelves from unit.

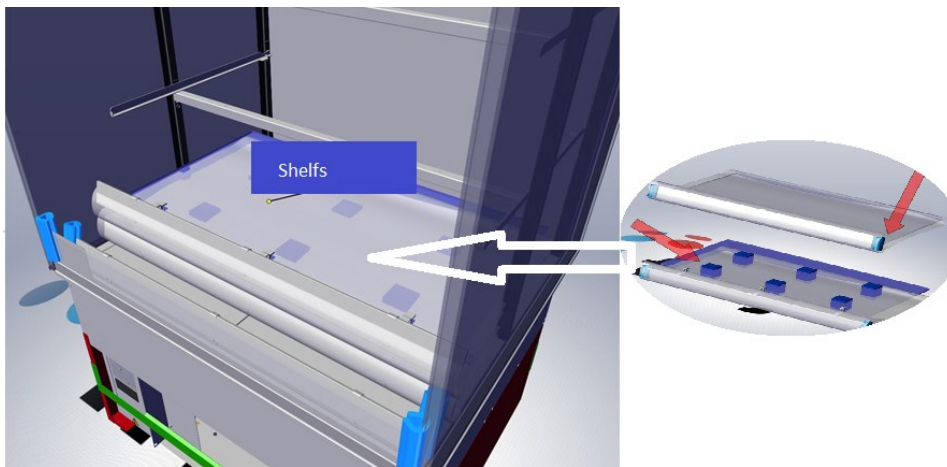

After placing cabinet in final position, remove tie-wraps which hold the shelf holders.

Make sure the shelf holders are placed in the required sleeve, for the wanted angled or straight position of the shelves.

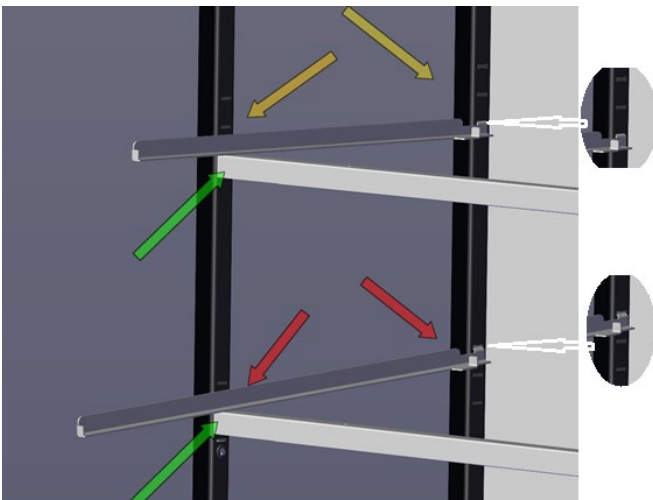

Shelf rails of top shelf should be placed in lowest position.

Shelf rails of middle shelf should be placed in highest position

5.4 MCC Drop-in Installation (Self Serve)

Doc. nr. 9124589	Rev. 0	Registration form. MCC Drop in installation instruction	
----------------------------	------------------	---	---

Safety instructions



WARNING

Self-contained units: Risk of Fire or explosion. Flammable refrigerant used.



WARNING

The maximum load on top of the unit may never exceed 10 kg.

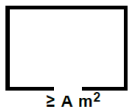

MINIMUM ROOM FLOOR AREA

Self-contained units: Refer to the data label on the unit for the required floor area.



WARNING

See installation instructions for grounding requirements.



WARNING

Always use the brakes on both front wheels when applicable:

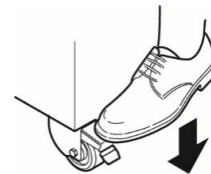

Cold units with remote CO2 (R744) refrigerant



WARNING

Remote R744 refrigerant is environmentally friendly but under high pressure. It is non-toxic with zero Ozone Depletion Potential (ODP) and very low Global Warming Potential (GWP).

Read this manual carefully and follow all precautions described herein.



SAFETY

Wear eye protection when working on the refrigeration system.



WARNING

Remote R744 filled under high pressure.(max. 60 bar)

- Do not tamper with the system.
- The system must be installed and maintained by qualified persons only.
- Fixate the unit to the floor.
- The ventilation openings of the cladding of the unit (including accessories) must not be blocked or covered. Ensure that the air circulation remain unobstructed.

Doc. nr. 9124589	Rev. 0	Registration form. MCC Drop in installation instruction	
----------------------------	------------------	---	---

MCC Hot version:

Important remark before installation:

When installing Front doors on the drop in unit, Please follow Front door installation procedure 9124652 or 9124721 depending on version, until the step in which the glass must be placed.

Placing the doors in a later stage, means the unit must be lifted again.

Installation must comply with:

- Make sure that the furniture is still easily accessible for service after installation by means of a removable hatch.
- Provide enough space to place the furniture with a stacker. Maintain the dimensions and minimum height as indicated in the installation manual.
- Provide adequate ventilation; keep the minimum air inlet and outlet opening as indicated on the last page.
- Make sure that the room / shop in which the furniture is placed meets the minimum dimensions as indicated in the installation manual.
- All warning signs / labels, minimum floor area label and Data plate must remain visible after installation.
- Operation of the appliance must be accessible.

Doc. nr. 9124589	Rev. 0	Registration form. MCC Drop in installation instruction	
----------------------------	------------------	---	---

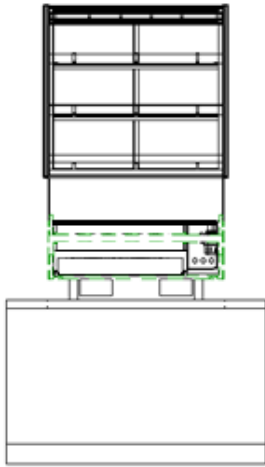

Step 1.

Position the cabinet above the cut-out in the counter top with a forklift and support it using the wooden beams supplied with the unit

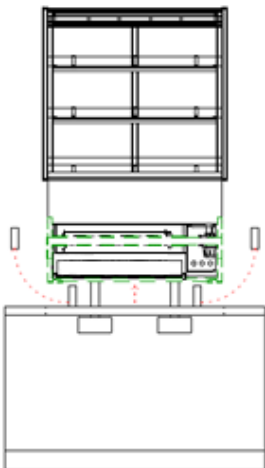

Step 2.

Lift the cabinet from below, using stable filler blocks and remove the wooden support beams

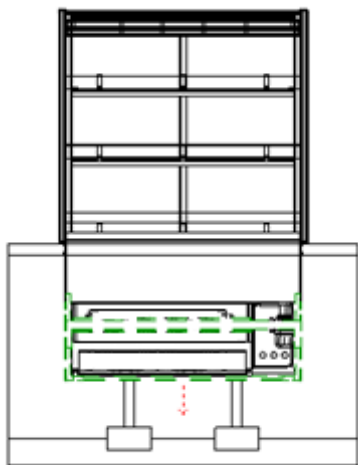

Step 3.

Apply sealant or a thin flexible foam seal around the cut-out in the countertop. Carefully lower the cabinet into the counter

Doc. nr. 9124589	Rev. 0	Registration form. MCC Drop in installation instruction	
----------------------------	------------------	---	---

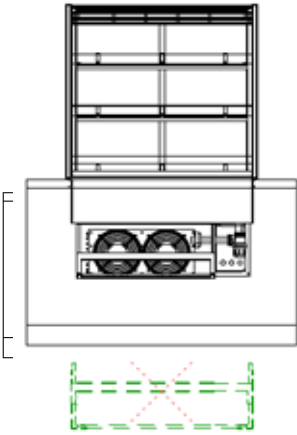
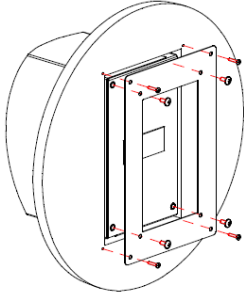
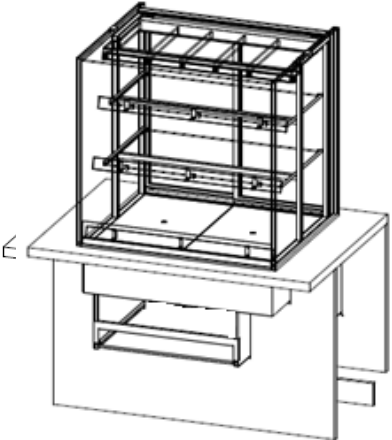
	<p>Step 4.</p> <p>Remove and discard the metal transportation frame.</p>
	<p>Step 5.</p> <p>Install the control panel using the supplied mounting plate and screws. (up to 1 meter from the original position)</p>
	<p>Step 6.</p> <p>Install a partition panel to prevent recirculation of hot condenser air. (refrigerated models only)</p>

Doc. nr. 9124589	Rev. 0	Registration form. MCC Drop in installation instruction	
----------------------------	------------------	---	--

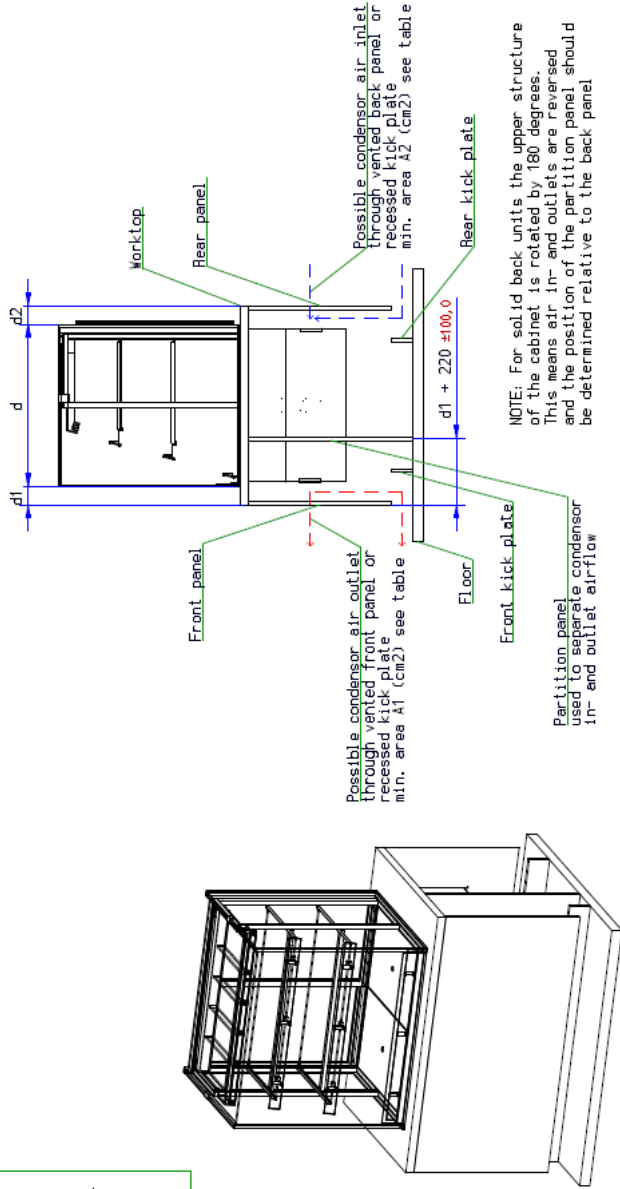

Control panel cut-out dimensions

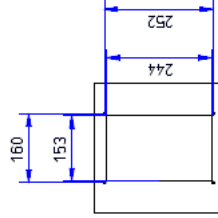

Partition panel dimension (only required for refrigerated units)

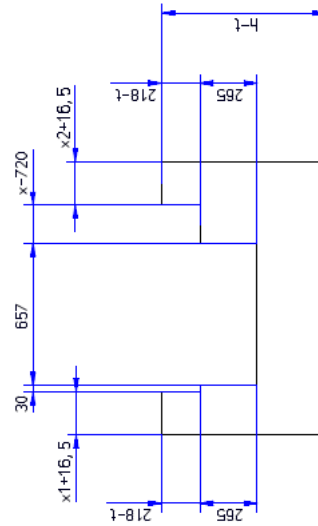

Worktop cut-out dimensions

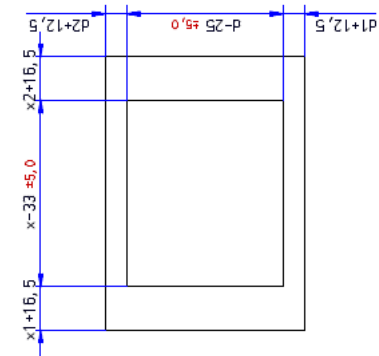

Legend

- x: Cabinet length
- d: Cabinet depth
- d1: Counter depth in front of the cabinet
- d2: Counter depth behind the cabinet
- x1: Counter length left of the cabinet
- x2: Counter length right of the cabinet
- t: Counter height (min. 500)
- t: Worktop thickness

Table

	x	d	A1	A2
MCC-90-3 C SS	900	750	500	1100
MCC-120-3 C SS	1200	750	700	1250
MCC-150-3 C SS	1500	750	900	1250
MCC-90-3 C FS	900	750	300	500
MCC-120-3 C FS	1200	750	500	1100
MCC-150-3 C FS	1500	750	700	1250
MCC-60-3 H SS	600	750	n.a.	n.a.
MCC-90-3 H SS	900	750	n.a.	n.a.
MCC-120-3 H SS	1200	750	n.a.	n.a.
MCC-60-3 H FS	600	750	n.a.	n.a.
MCC-90-3 H FS	900	750	n.a.	n.a.
MCC-120-3 H FS	1200	750	n.a.	n.a.

REVISION	REV. DATE	REMARK	Rev. tolerance	Surface treatment	Rev. tolerance
MATERIAL					
DRAMA	van Bergen	APPROVED			
STATUS	In Progress	DATE	08-10-2020		
PROJECT	GBB	PROJECT NUMBER	9124554		
SCALE	1:20				
DESCRIPTION	Installation instructions MCC drop-in				
REF.					
SIZE					A3





6.0 Installation Front door section (first version)





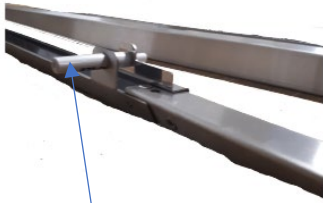
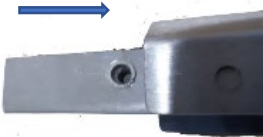

01	29.01.2021	cabl e	
REVISION	REV. DATE	REMARK	
Tol. principle		Gen. tolerance	Surface treatment
		Geom. tolerance	
MATERIAL			
MATERIAL ART. NUMBER	DRAWN	Kappers	APPROVED
UNIT mm	STATUS	In Progress	DATE 04.03.2020
SCALE 1:10	PROJECT		DRAWING NUMBER 9380104
REMARKS			
DESCRIPTION			ART. NUMBER
Ass. MCC-90 SS front door module			9380104
			REV. A
			SIZE A4

Pos. Number	Amount	Unit	Article number	Description
1	1	pc	9380105	Ass. Front door top supports MCC-90
2	1	pc	9380108	Ass. MCC-90 Front door [Left]
3	1	pc	9380109	Ass. MCC-90 Front door [Right]
4	1	pc	9380107	Ass. bottom support self-close door MCC-90
5	2	pc	9383040	Stainless steel rod \varnothing 2mm



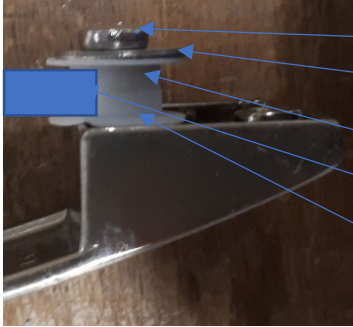

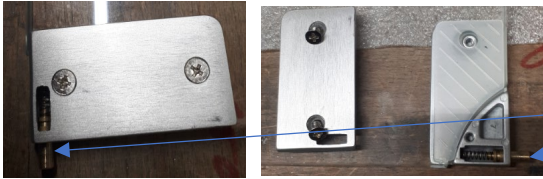
6.0 Installation Front door section (first version)

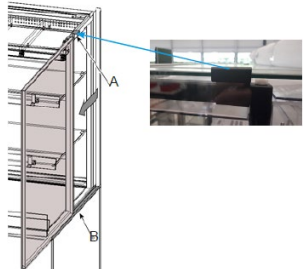
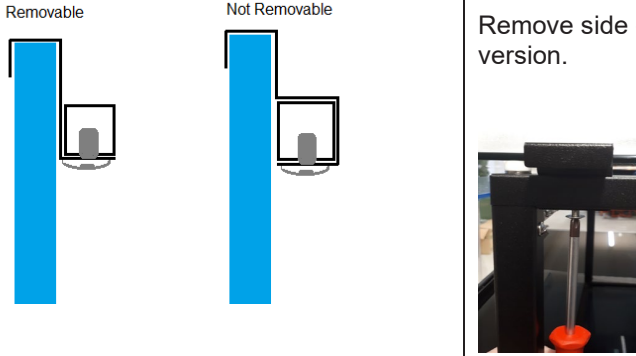
	<p>Step 1.</p> <p>Remove any remaining protective coatings from the stainless steel parts provided.</p>
 <p>Place soft close damper</p>	<p>Step 2.</p> <p>Depending on variant:</p> <p>With standard underframe: Remove front underframe panel (two screws, one on each bottom corner).</p> <p>Drop-In: Raise the unit at least 30cm from tabletop level in order to access the screws for the child-guard. Be careful to support the unit such that no components or connections underneath the base of the unit are damaged while doing so.</p>
	<p>Step 3.</p> <p>Slide profiles into each other.</p> <p>Be careful to guide the rivet nut into the profile.</p>
	<p>Step 4.</p> <p>Slide square profiles into each other.</p>
	<p>Step 5.</p> <p>Place end cover on profile end.</p>
	<p>Step 6.</p> <p>Mount handle on glass door.</p>



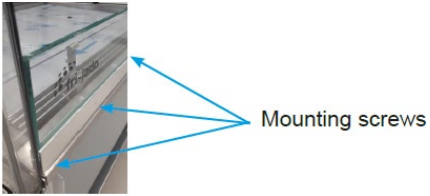

6.0 Installation Front door section (first version)

	<p>Step 7.</p> <p>Make sure to use place the white nylon rings on both side of the glass.</p>
	<p>Step 8.</p> <p>Bolt</p> <p>Washer (steel)</p> <p>Nylon washer with collar 1 </p> <p>Glass</p> <p>Nylon washer with collar 2 </p>
	<p>Step 9.</p> <p>Place hinge on glass door. One on the bottom, one on top.</p> <p> (High adjustment washer 3701241 and 3701242)</p> <p>For placement washers wait till step 22</p>
	<p>Step 10.</p> <p>Place glass between nylon sheets Glass position</p>
	<p>Step 11.</p> <p>Remove side glass (both sides)</p> <p>CAUTION: Once past the top guide, the glass pane might fall if not properly held</p>
	<p>Step 12.</p> <p>Remove side glass holder, depending on version.</p>

6.0 Installation Front door section (first version)

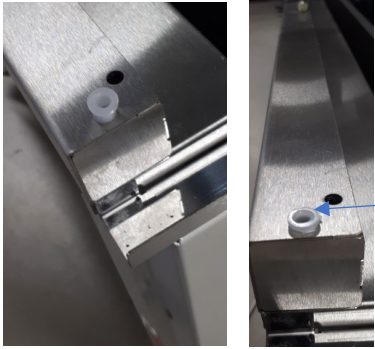
	<p>Step 13.</p> <p>Remove white stud.</p> <p>Remove top column cover (two screws)</p>
	<p>Optional Step 14. (only necessary when top column is stuck)</p> <p>Remove back cover(s) left and right (sliding door stopper).</p> <p>Both fixed with three screws.</p>
	<p>Step 15.</p> <p>Place new (longer) top column cover (two screws)</p> <p>Re-mount side glass holder. (the first screw)</p> <p>Mount second screw just before back column</p> <p>Replace white stud removed in step 13.</p>
	<p>Step 16.</p> <p>Remove screws (3x) to detach child guard from the bottom (recycle these screws to fix the bottom support!)</p>  <p>Dispose of the child guard in accordance with local regulations</p>

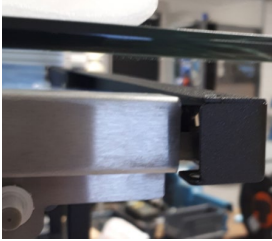
6.0 Installation Front door section (first version)

	<p>Step 17.</p> <p>Place square profiles (prepared in step 4) in previous position from child glass.</p> <p>Use same screws to mount.</p> <p>Place nylon bearing in profile (packet in bag with hinge).</p>
	<p>Step 18.</p> <p>Place bumper rubber in bottom profile (two).</p>
	<p>Step 19.</p> <p>Place top profile set (step 3) in top column cover.</p>
	<p>Step 20.</p> <p>Place additional white stud on top of top column cover</p> <p>Place nylon bearing in top column cover from below.</p>
	<p>Step 21.</p> <p>Put glass door in place.</p>
<p style="text-align: center;">Very carefully, try to close the glass door(s). They are not adjusted in height yet,</p>	

6.0 Installation Front door section (first version)

so they can scratch the bottom plate.

Very carefully, try to close the glass door(s).

**They are not adjusted in height yet,
so they can scratch the bottom plate.**

Always place height adjustment nylon washer first before placing the bottom hinge pin in its bearing

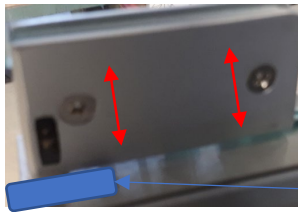

Step 22.

Adjust glass door height by adjusting position in the hinge (place in step 9).

Also available in kit, 3701241 and 3701242
Height adjustment nylon washer set.
See step 9.



Height adjustment is done by repositioning the hinge on the glass, or adding the height adjustment washer(s).

6.1 Installation Front door section (Second version)

9124721 Service Instruction Installation front doors MCC (2nd version)

The technician, working on the unit will be fully responsible for abiding the locally prevailing safety rules and regulations.

Technical activities must be performed by qualified and authorized persons only.

Before working on any electrical part, or dismantling the unit by means of using a screwdriver or any other tool, **ALWAYS REMOVE THE POWER PLUG** from the main outlet.



6.1 Installation Front door section (Second version)

Doc. Nr.	Rev.	Mounting instruction
9128156	2	Front door mounting



Top Mounting

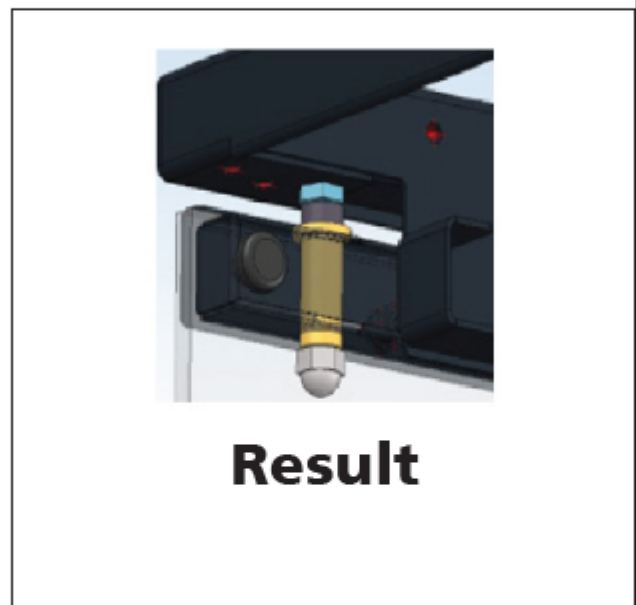
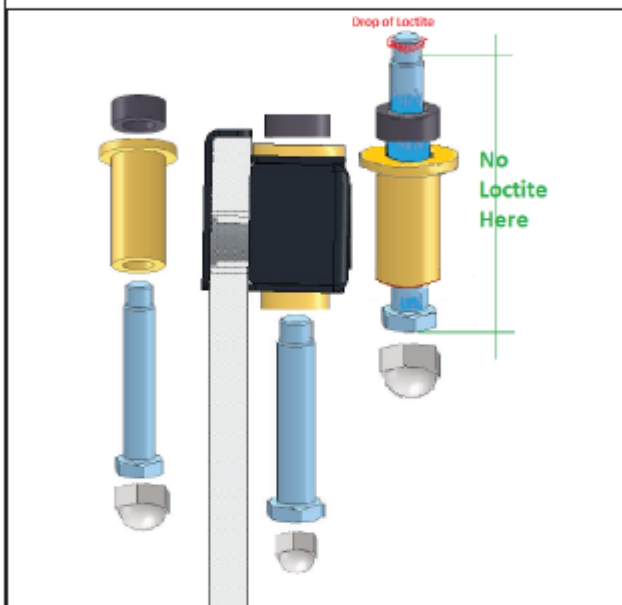

Bottom Mounting

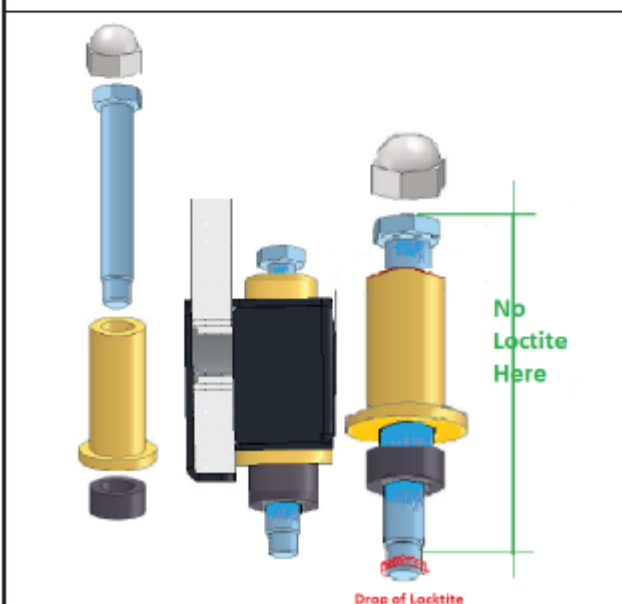

6.1 Installation Front door section (Second version)

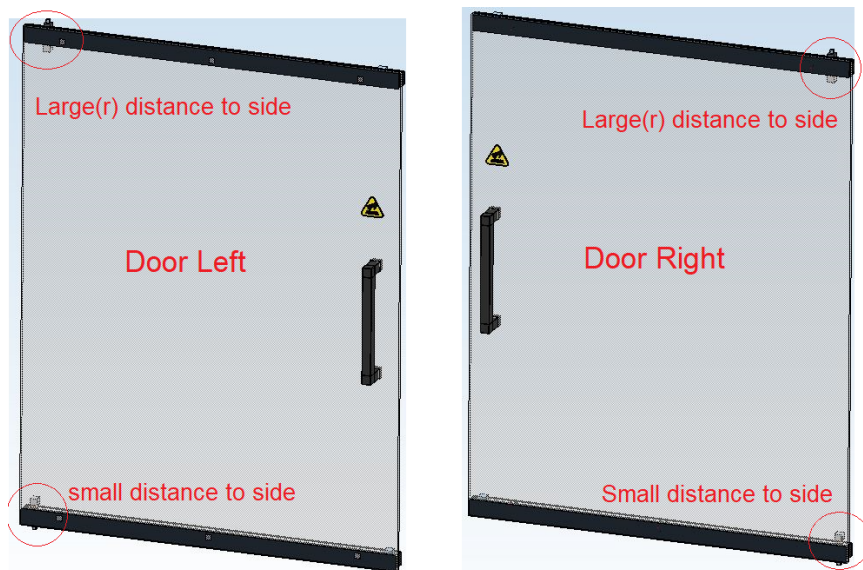

6.1 Installation Front door section (Second version)

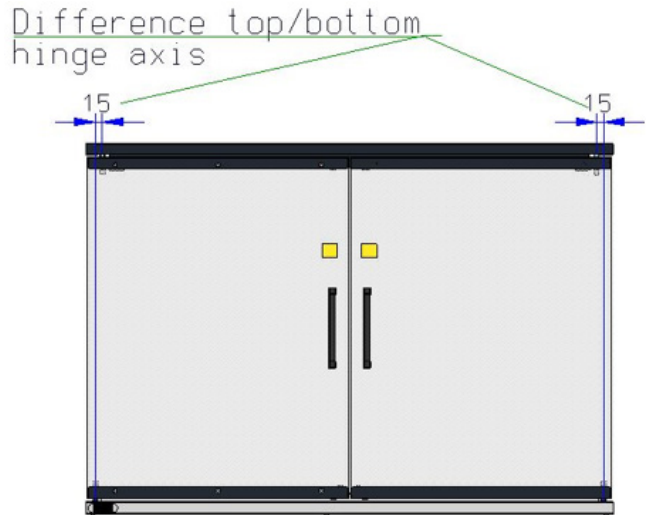
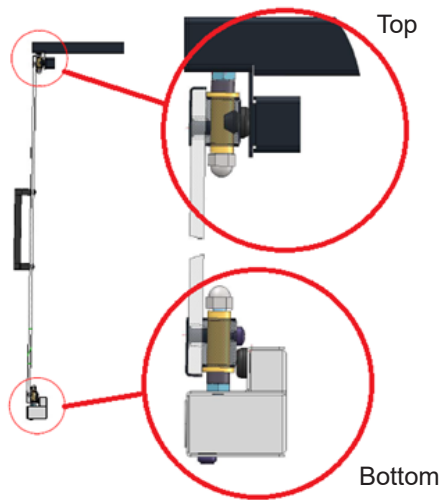

Depending on variant:

With standard under frame:

Remove front under frame panel (two screws, one on each bottom corner).

Drop-In:

Raise the unit at least 30cm from tabletop level in order to access the screws for the child-guard. Be careful to support the unit such that no components or connections underneath the base of the unit are damaged while doing so.

Step 1.

Remove Child guard:

Refer service manual chapter replacement and adjustment

- a. Remove front panel.
- b. Loosen mounting screws (3x depending on unit length) of child guard. *Screwed from underneath.*
- c. Remove Child guard
- d. Position under beam on place of child guard
- e. Fasten mounting screws.



6.1 Installation Front door section (Second version)

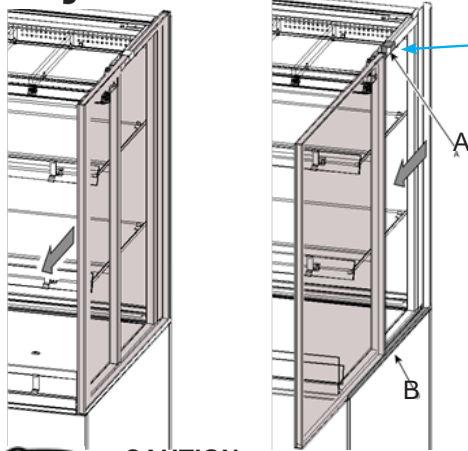

CAUTION:

Once past the top guide, the glass pane might fall if not properly held. Hence do not leave it standing upright without being supported by both guide rails or holding it.

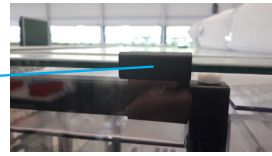

Step 2.

- a. **Remove side glass** both sides:
- b. Slide the double glass pane towards the front along the top (A) and bottom (B) guiding rails.
- c. The side pane can be removed from the unit once it has slid entirely past the top guide.

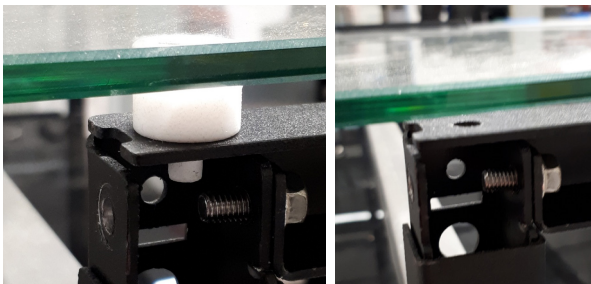

HOT

COLD



Step 3.

- a. **Remove white (or black) stud**, both sides. *(Black stud is screwed in)*

Step 4.

- a. **Remove top air guide or assy. air box** (which is applicable depending on version).

Step 5.

- a. **Remove side glass holder**, left and right.



Step 6.

- a. **Remove or loosen back cover(s)** left and right (sliding door stopper).

Both fixed with three screws.



6.1 Installation Front door section (Second version)



Step 7.

- a. **Remove top column cover** by removing last screw. (one each side)

Step 8.

- a. **Place new (longer) top column cover(s)/ window support** (two screws).
- b. Mount screws in new top column cover

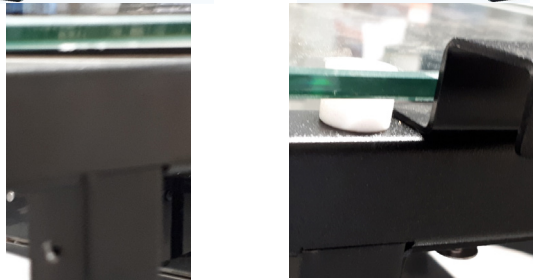
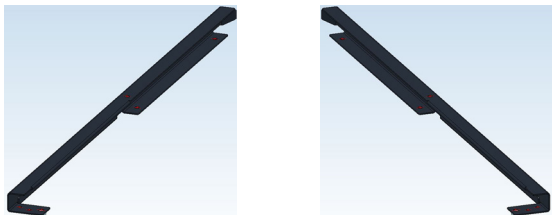

Step 9.

- a. **Replace white (or black) stud** removed earlier.



Step 10.

- a. **Replace side glass holder** removed earlier.



Step 11.

- a. **Place top front beam** in side profiles.
Slide the beam into the front of the profile.



Step 12.

- a. **Fasten the top front beam** in side profiles with screws. (both sides)

View from underneath

6.1 Installation Front door section (Second version)

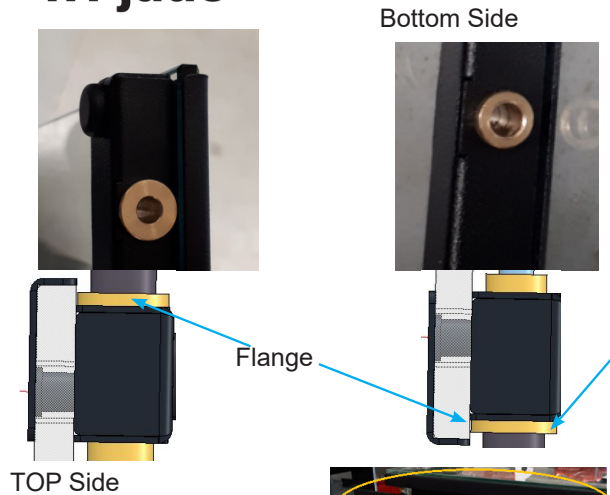

Step 13.

- a. **Check placing bearing(s)** in door, one in the top, one at the bottom.

Make sure the flange of the bearing sits opposite of the glass.



Step 14.

- a. Place a door on the lower beam, let it stick out of the unit.



CAUTION:

Be careful not to touch the top beam with the glass door.

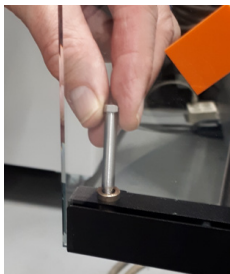

Step 15.

- a. Place hinge pin into bearing

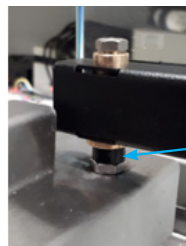
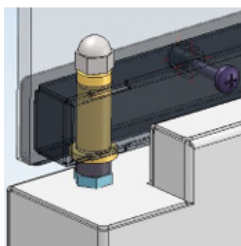

Step 16.

- a. Place distance ring on hinge pin.

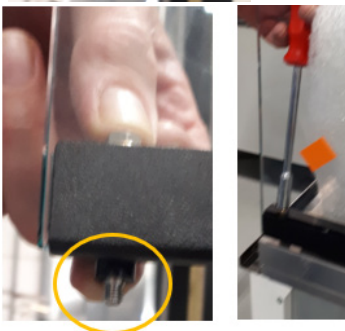

Step 17.

- a. Fasten hinge pin loosely, making sure the door is kept in place

6.1 Installation Front door section (Second version)

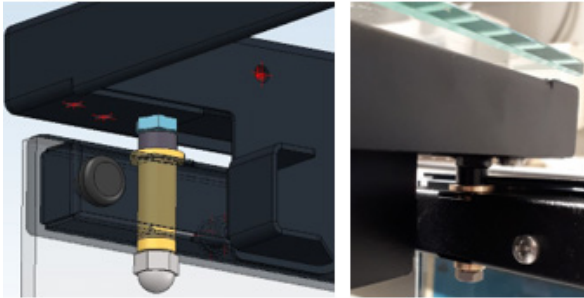

Step 18.

- a. Place top hinge pin into top bearing.
- b. Place distance ring on top hinge pin.
- c. Fasten top hinge pin, tighten tight !

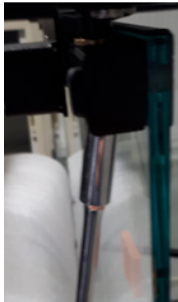

Step 19.

- a. Fasten lower hinge pin, tighten tight !



Step 20.

Repeat step 14 till 19 for each front door, depending on MCC variation.

Replace removed sliding doors covers in reverse order.

Replace top air guide or assy air box, in reverse order. If this does not fit anymore please order:

Top Mounting

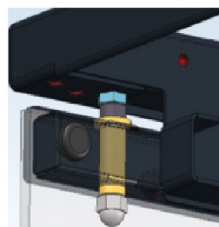
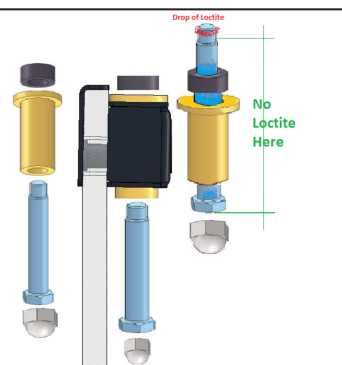

Result

Bottom Mounting

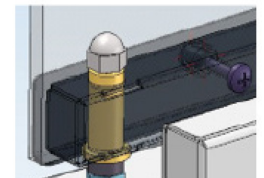
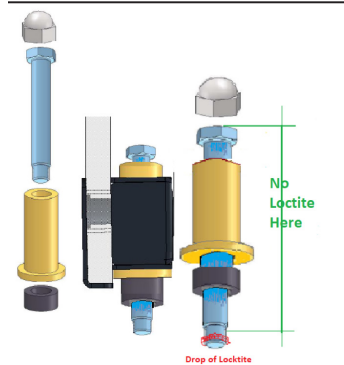

Result

7.0 Operation MCC Hot

7.0 Hot Units



The display value is not the product temperature!



When switched on, the display performs a lamp test; the display and LED's will flash for several seconds to check all function are working correctly.



7.0.1 Control Panel

On/Off Switches (hot unit).



Heating



Lighting



Key Function	
	Press for one second: UP Press and hold: ON/OFF
	Press for one second: DOWN
	Press for one second: BACK Press and hold: PULL-DOWN
	Press for one second: TEMPERATURE SETPOINT/OK Press and hold: MENU
Display Icons	
	Night mode (Energy saving)
	Fan running
	Active alarm
	Unit (°C or °F)

7.0.2 Factory settings

The unit is set at 149 °F (65 °C) intake air temperature.
If required this temperature can be adjusted to some degree.

At a ambient temperature of 68 °F (20 °C) and an initial core temperature of 194 °F (85 °C) the factory settings of the unit's temperature ensure a constant core temperature of at least 145.5 °F (63 °C) for 4 hours.

7.1 Operation MCC Hot <access controller>

7.1.0 Menu Structure

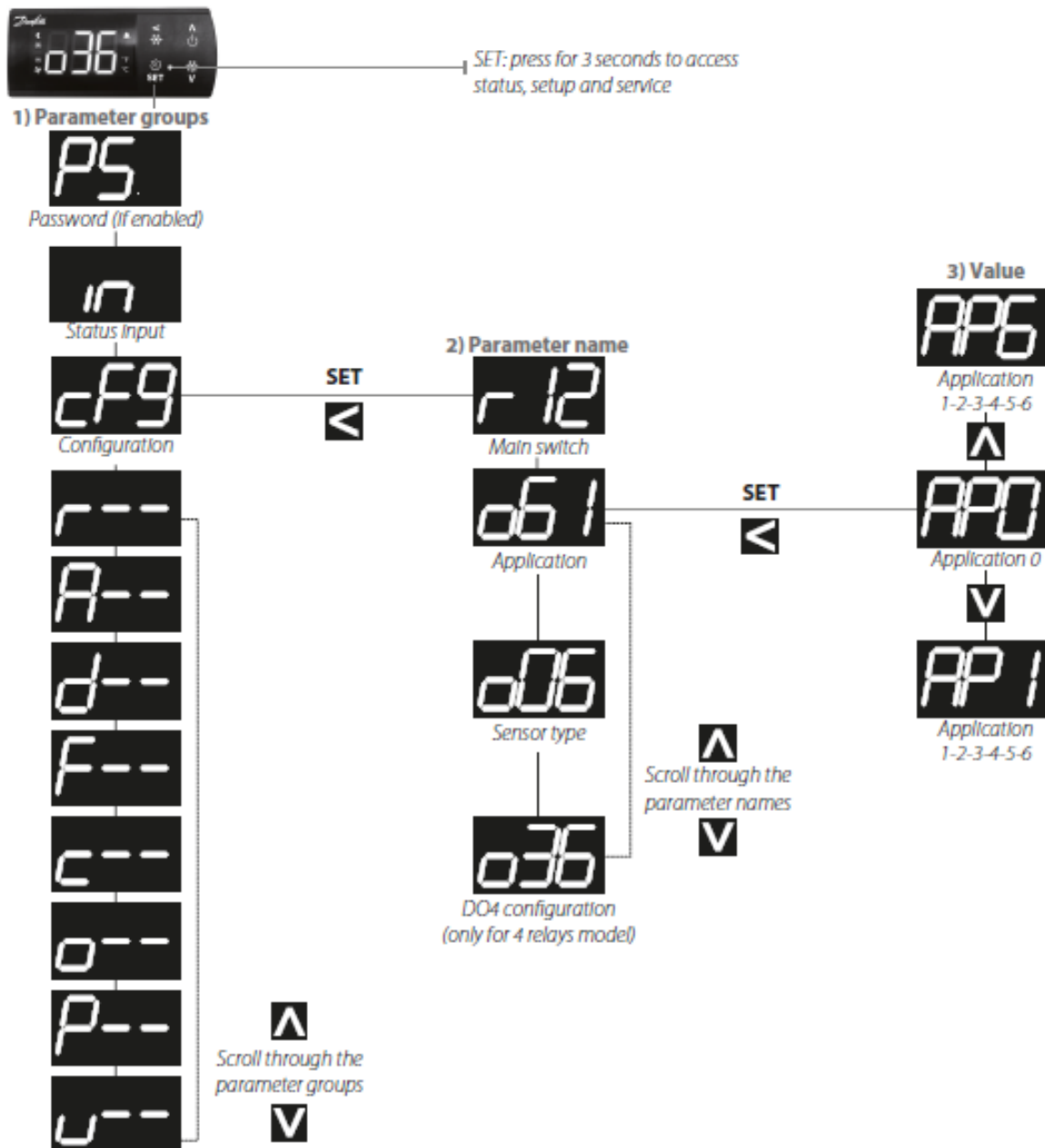

Quick Configuration via “cFg” menu

- Press SET for three seconds to access the parameters groups.
- Select “cFg” menu and press SET to enter. The first menu “r12” (main switch) is displayed.
- Switch OFF main switch (r12=0) for changing the pre-installed application.
- Press UP/DOWN to scroll through the parameter list.
- Configure the “o61” parameter to select a pre-installed application:
- Press SET to access the “o61” parameter.
- Press UP/DOWN to select an application.
- Press SET to confirm, “o61” is displayed.
- Continue to set the next parameters in the “cFg” menu.

7.2 Operation <access controller>

Adjust set point temperature

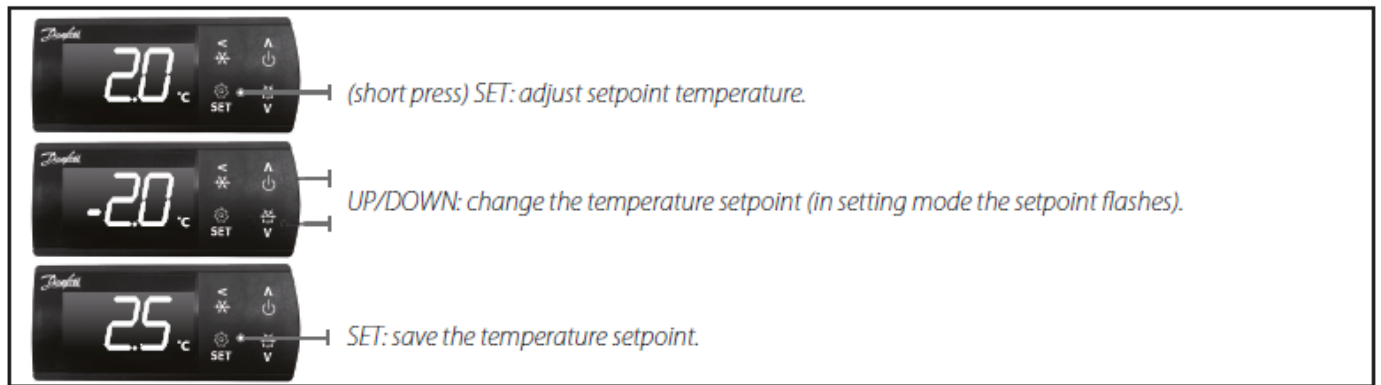

View active alarm

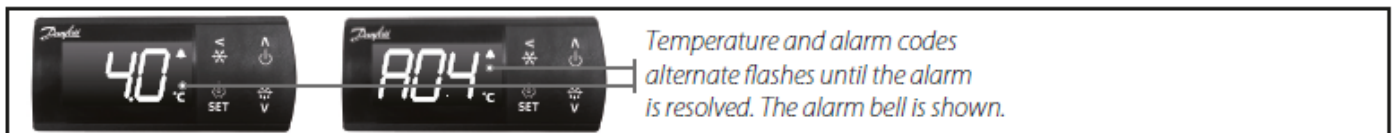

Unlock keyboard

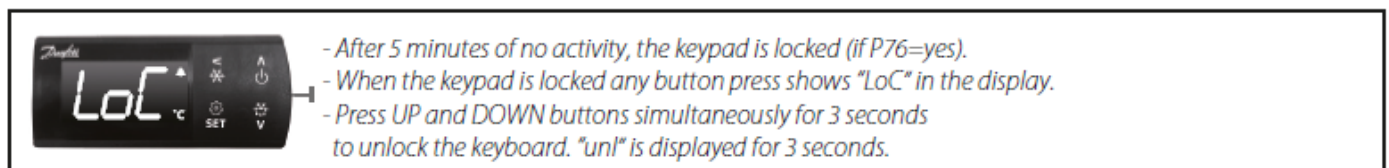

7.2.0 Switching-on the unit

- Switch the unit on, by means of the main switch (located top front, and/or top back)
- Switch on controller for specified shelf (Multi-temp only)
- Preheat the unit/shelf for at least 30 minutes.
- Switch on the lighting with appropriate switch (next to controller)

7.2.1 Loading the unit

- Only place products that have a core temperature of at least 185 °F (85 °C) or above.
- Only with packaged hot products in bags or containers that are suitable for this purpose, withstanding these temperatures.
- To ensure a good contact with the heated trays, only place a single layer of products.
- The maximum carrying-capacity per shelf is 30 kg/m (66 lbs/m), by equal load.

8.0 Service instruction controller replacement

9124747 Service Instruction Controller replacement

Due to supply issues, Fri-Jado uses different kind of controllers as placed in our units from factory.

Four possible controllers are used.

For Service replacements we only deliver Eliwell ICPlus 902

Please find below the difference in connections and parameters.

For disassembly instructions refer to the original service manual for the unit at hand.

**Service
Replacement-
unit,
(UL certified)**

Eliwell ICPlus 902
9281071 (programmed)
9381056 (unprogrammed)

We use four different types of controllers:



Eliwell ICPlus902

Eliwell IDNext 961
9381054



Eliwell ID Next 961

ERC 211
9221109



Danfoss ERC211

VDH Alfa 31
9381055



VDH Alfa 31

Eliwell ICPlus 902
9281071 (programmed)
9381056 (unprogrammed)



ICPlus 902 (NTC/PTC - 15A (24Vac, 230Vac))

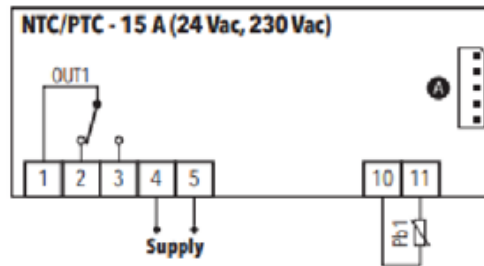

4
5
1
3
10
11

ERC 211
9221109



4.4.1| ERC 211 - connection diagram

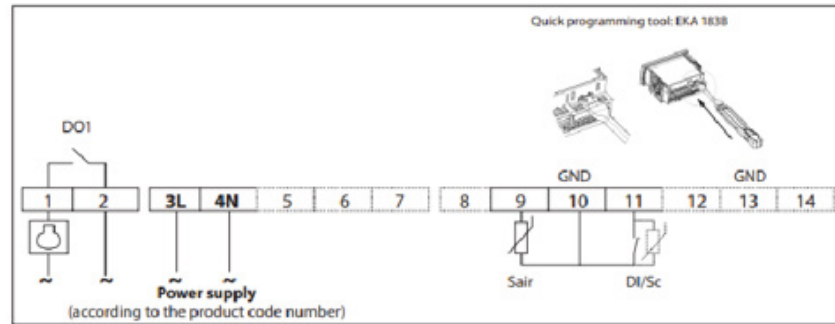

3L
4N
2
1
9
10

Eliwell IDNext 961 **IDNext 961 P (230 Vac)**
9381054

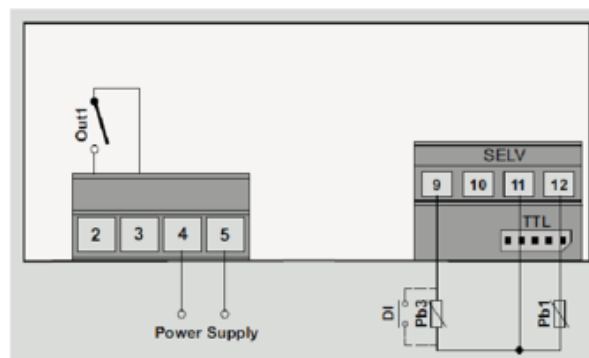

4
5
3
2
11
12

VDH Alfa 31
9381055



- 1
- 2
- 3
- 5
- 9
- 10

**ALFA(NET)
3X-series**

***REMARK:** To terminate RS485-Network
Connect a 250 Ohm resistor between
Line-A and Line-B at both cable-ends

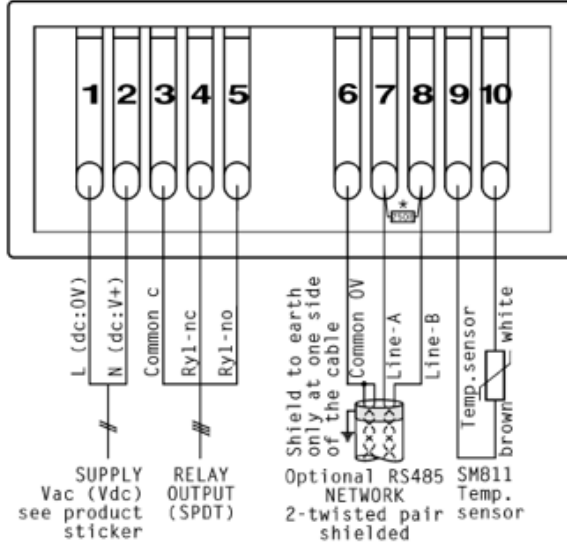

Difference in connections between the four controllers

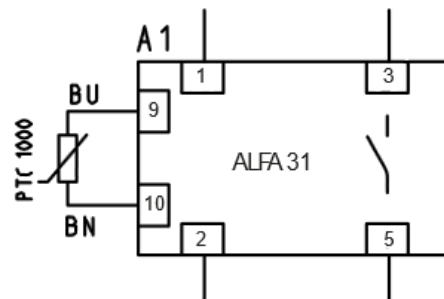
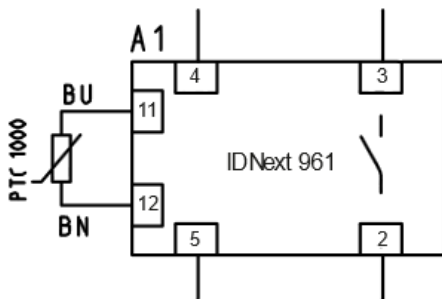
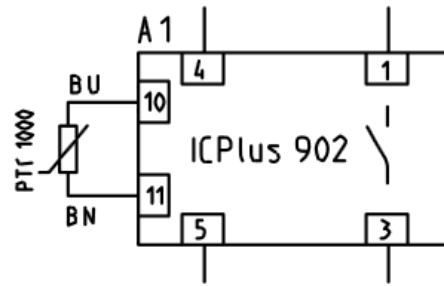
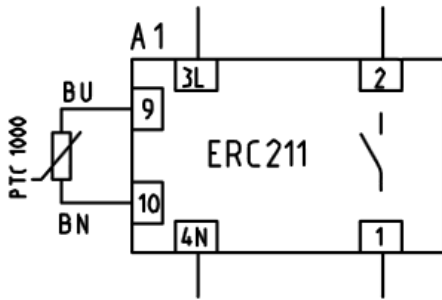

Normal Parameter list	Unit	Type	USA	Custom	961 next	VDH	902 plus	Rev.
9124657	MCC	H SS	USA				X	A
9124658	MCC	H FS	USA				X	A

8.2 Parameter setting Hot Self Serve

<u>Doc. nr.</u> 9124657	<u>Rev.</u> C	Registration form. Settings – 149 °F	
-----------------------------------	-------------------------	--	---

MCC Hot SS USA	
MDD USA	

Controller: Eliwell ICPlus 902

User parameters:

SP1	Temperature set point	149	°F
dF1	Differential	2	K
HS1	Max set point limitation	158	°F
LS1	Min set point limitation	32	°F
LoC	Keypad lock n(0)=lock disabled y(1)=lock enabled	n	
ndt	Display with decimal point, n(0)=no y(1)= yes	y	
CA1	Display offset	0	°F
H00	Sensor type, 0 = ptc, 1 = ntc	0	

Installer parameters:

rE1	HC1	Cold "C(0)" or hot "H(1)" operation	H	
	HA1	Max temp alarm	212	°F
diS	dro	Unit of measurement (0 =°C 1 =°F)	1	

8.3 Parameter setting Hot Full Serve

<u>Doc. nr.</u> 9124658	<u>Rev.</u> C	Registration form. Settings – 194 °F	
-----------------------------------	-------------------------	--	---

MCC HOT FS USA	
----------------	--

Controller: Eliwell ICPlus 902

User parameters:

SP1	Temperature set point	194	°F
dF1	Differential	2	K
HS1	Max set point limitation	203	°F
LS1	Min set point limitation	32	°F
LoC	Keypad lock n(0)=lock disabled y(1)=lock enabled	n	
ndt	Display with decimal point, n(0)=no y(1)= yes	y	
CA1	Display offset	0	°F
H00	Sensor type, 0 = ptc, 1 = ntc	0	

Installer parameters:

rE1	HC1	Cold "C(0)" or hot "H(1)" operation	H	
	HA1	Max temp alarm	212	°F
diS	dro	Unit of measurement (0 =°C 1 =°F)	1	

9.0 Maintenance



CLEANING AND MAINTENANCE

WARNING



Never use a water hose for cleaning.
Water can seep into the unit through the ventilation holes of the unit.

Because of hygiene aspects and optimum condition of the unit it is of up most importance to keep a daily cleaning pattern from first use onwards.

Maintenance schedule for users

Item	Action	Frequency
Inside	Clean	Daily
Glass Panes	Clean	Weekly
Outside	Clean Use Stainless Steel cleaning spray to remove stains, and restoring the gloss.	Weekly
Condenser	Clean	Monthly

For detailed cleaning instructions refer to User manual chapter 5



Examples:

Cleaning possibility the top glass pane all units

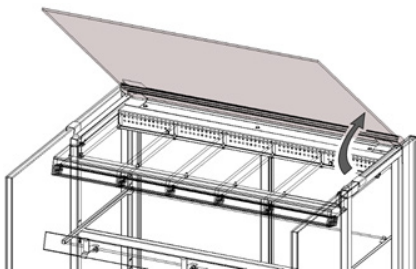

Cleaning possibility side pane all units

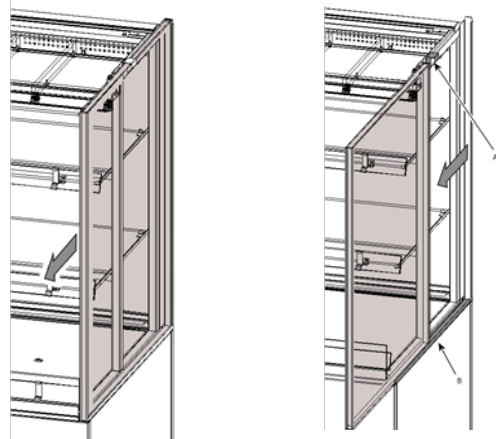

Cleaning possibility off the top air guides



10.0 Trouble Shooting

10.0.0 Problems which can be checked by user

Each user can check the following points as mentioned in the user manual:

- Is the power supply OK?
- Check the fuses and the earth leakage switch in the meter cup board.
- Are all the switches in the correct “on” position?

Item	Malfunction	Possible action
Unit	Unit does not work	<ul style="list-style-type: none"> • Check the power supply. • Are all switches in the correct position.
Unit	Display shows error code	<ul style="list-style-type: none"> • Contact your supplier or service agency.
Lamp	Does not light up	<ul style="list-style-type: none"> • Switch ON.
Mains cord	Damaged	<ul style="list-style-type: none"> • Replace.
Window	Damaged	<ul style="list-style-type: none"> • Replace.

10.0.1 Replace the mains cord



WARNING

Hazardous electrical voltage.

If the mains cord is damaged, it must be replaced by a fully certified and qualified person, in order to avoid hazards.

10.0.2 Heating element testing (Self Serve units)

Resistance

1. Remove wiring (two) from the element.
2. Connect the probe of the multimeter to each of the wires.
3. Test the probe with a Ohm tester, values see below.

Current

1. Place ampere pliers around red wire of Element.
2. In normal working condition, test current see below. (230V version)

		MCC60			MCC90			MCC120		
Shelf	Power	Current	Resistance	Power	Current	Resistance	Power	Current	Resistance	
	Watt	Ampere	Ohm	Watt	Ampere	Ohm	Watt	Ampere	Ohm	
Top	465	2,02	113,7	700	3,04	75,6	935	4,07	56,6	
Middle	570	2,48	92,8	850	3,70	62,2	1130	4,91	46,8	
Bottom	750	3,26	70,5	1125	4,89	47,0	1500	6,52	35,3	

10.0 Trouble Shooting

10.0.5 Heating element testing (Full Serve units)

Resistance

1. Remove wiring (two) from the element.
2. Connect the probe of the multimeter to each of the wires.
3. Test the probe with a Ohmtester, values see below.

Current

1. Place ampère pliers around red wire of Element.
2. In normal working condition, test current see below. (230V version)

		MCC60			MCC90			MCC120		
Shelf	Power	Current	Resistance	Power	Current	Resistance	Power	Current	Resistance	
	Watt	Ampere	Ohm	Watt	Ampere	Ohm	Watt	Ampere	Ohm	
	1500	6,5	35,25	1800	7,8	29,3	2400	10,5	22	

10.0.6 PTC sensor testing (Hot Unit)

1. Remove wiring from the sensor.
2. Connect a temperature tester to the probe of the sensor for comparison.
3. Test the probe with a Ohm tester.

Nominal resistance	1000 ohm at 0 °C
Measuring accuracy	Class B
Temperature range	-40 – 100 °C
Cable material	PVC, 2 x 0.22 mm ²
Sensor tube	18/8 stainless steel
Time constant	15 seconds
Enclosure	IP67
AMP-Plug (selected sensors only)	AMP ital mod 2, housing 280 358, Crimp contact 280 708-2

R (Typ.) [Ohm]	Temp. [°C]	Temp. [°F]
1117	30	86
1078	20	68
1039	10	50
1000	0	32
961	-10	14
922	-20	-4
882	-30	-22

11.0 Trouble Shooting Symptoms and causes

Symptom	Possible causes
No power	<ol style="list-style-type: none"> 1. Main circuit breaker open 2. Fuse Blown 3. Loose wire connection
Main fuse or breaker blown	<ol style="list-style-type: none"> 1. Wiring incorrectly 2. Short circuit heating element 3. Short circuit fan element 4. Short circuit wiring
Illumination does not work	<ol style="list-style-type: none"> 1. Led malfunction 2. Tumble switch malfunction 3. Led driver malfunction 4. Loose / short circuit wiring connection
No heating	<ol style="list-style-type: none"> 1. Heating element malfunction 2. Relay malfunction 3. Loose wiring connection 4. Thermostat malfunction 5. Loos wiring connection 6. Air flow not functioning
Unit does not reach desired temperature	<ol style="list-style-type: none"> 1. Heating element malfunction (HOT unit only) 2. Cooling unit malfunction (COLD unit only) 3. Strong air current along unit / Draft 4. Burned contact on contactor 5. Sensor malfunction 6. Sliding doors not closed
No indication on controller	<ol style="list-style-type: none"> 1. Electronic controller malfunction 2. Blown fuse 3. Loose wiring connection
No air flow inside unit	<ol style="list-style-type: none"> 1. Fans do not work 2. Blown fuse 3. Loose wiring connection 4. 24Vdc power supply malfunction
Products dry out (Hot FS only)	<ol style="list-style-type: none"> 1. No water intake / Not filled by hand 2. No water intake, supply not open 3. No water intake, inlet valve blocked, or defective 4. No water, or too much water, Water level sensor

11.1 Trouble Shooting Analytical description

Description of part	Symptoms	Possible causes	Solution / Action
Contactor	Contactor does not work	Wiring Coil malfunction Contact burned	Check wiring Check resistance of coil +/- 525Ω Check the contacts Replace contactor
Heating element	Unit is not reaching the set temperature	Wiring Element malfunction Air flow not Working, Fan's not turning	Check wiring Check power on elements per shelf Check current with AC current tester Check Resistance (refer 6.4) Replace element Check wiring Check power on fans per shelf Replace Air box / Power Supply
Tumble switch	Light, heating or cooling does not switch on	Wiring Contact burned	Check wiring Check the voltage on "in" and "output"
LED	Light does not turn on	Wiring LED broken Led driver defect	Check Wiring Replace LED Replace LED driver
Electronic thermostat	Display does not light up The unit is not reaching the set temperature	Wiring Loose sensor Thermostat Malfunction Thermostat setting	Check wiring Check sensor Replace thermostat Check parameters

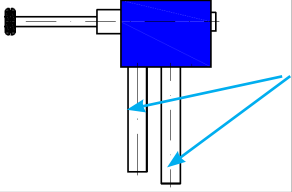
PTC 1000 sensor	<p>The unit is not reaching the set temperature or does not heat up at all</p> <p>The unit becomes too hot</p>	Broken Sensor Loose sensor Broken Sensor Loose sensor	Replace sensor Check sensor wiring Replace sensor Check sensor wiring
Water intake (Hot FS only)	<p>Not filling of Humidification tray</p> 	Water supply closed Inlet Valve Contaminated of water level sensor	Open water supply Check, clean or replace Clean or replace

12.0 Replacement and Adjustments

12.1 Top glass replacement

1. For replacement, open top glass pane entirely.



Be aware of the weight of the glass.

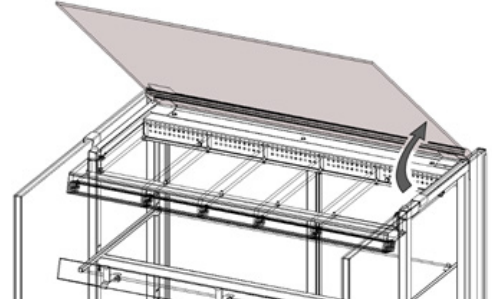

2. Remove the air guide or the air box by simply lifting them out.

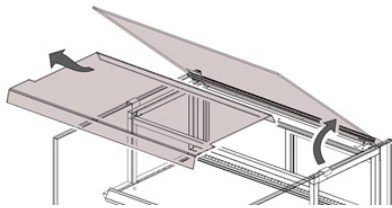

3. Loosen the adjusting screws which secure the glass with a torques key TX15
Depending on the length of the unit, there are 4, 6 or 8 screws.

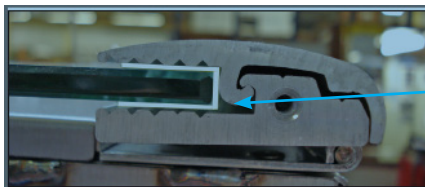

4. When refitting the glass, make sure the silicon protection profile is on.

12.2. Side glass replacement

The side pane glass of the units can easily be replaced.

1. Slide the double glass pane towards the front along the top (A) and bottom (B) guiding rails.
The side pane can be removed from the unit once it has slid entirely past the top guide.

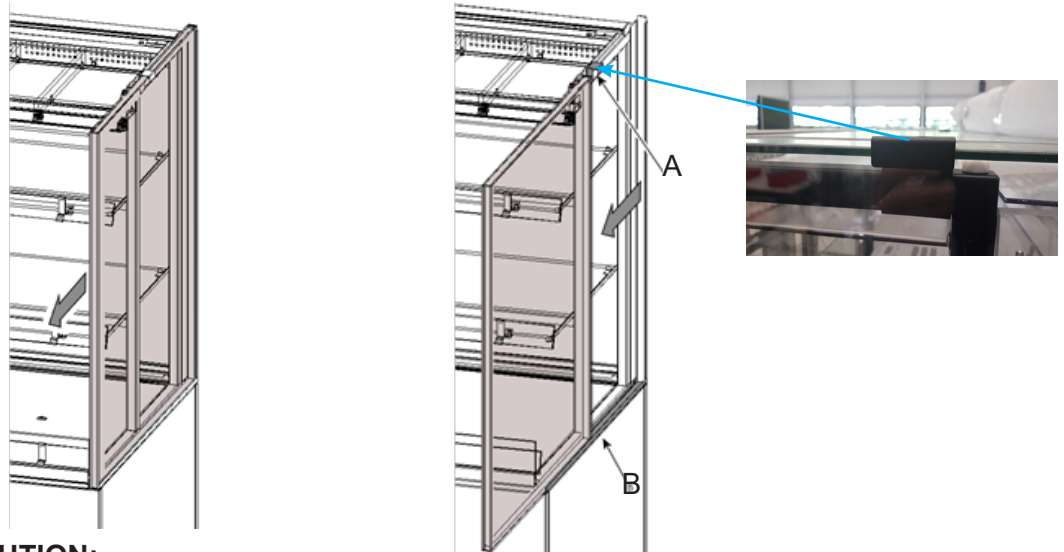

CAUTION:

Once past the top guide, the glass pane might fall if not properly held.



Hence do not leave it standing upright without being supported by both guide rails or holding it.

2. Before placing a new side pane, clean the guiding rails. (Top, back and bottom)
3. Before sliding the new pane into the rails, ensure the transparent sides of the pane are facing forwards and up.
4. Slide it all the way back till the front of the pane is in line with the front plating.

12.4 Sliding door Replacement (First version (magnets in rails))
 (Two different versions, please select appropriate type)

In order to replace the sliding doors, take following step:

1. Remove Sliding door stopper (three screws). Left and right side.
2. Remove rail cover, loosen mounting screws and pull cover backwards.



Screws

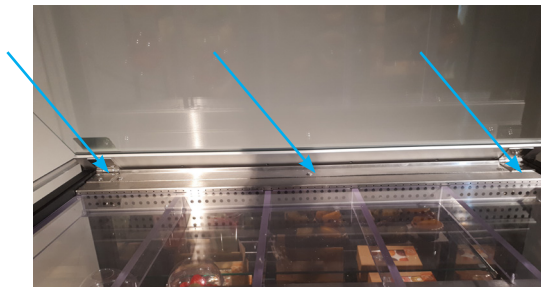

3. Remove rail stopper (two screws on top).
4. Remove sliding door(s).



5. Replace in reverse order.

12.4.1 Sliding door Replacement (Second version, magnets in door)

(Two different versions, please select appropriate type)

Recognizable: Two screws on top of rail cover. Top back side, two left and two right.



In order to replace the sliding doors, take following step:

1. Remove Sliding door stopper (three screws). Left and right side.
2. Remove Rail cover, four screws, on top of rails two left and two right.
3. Remove rail stopper
4. Remove sliding door(s).
5. Replace in reverse order.

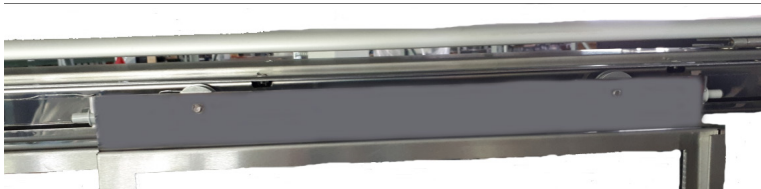

12.5 Sensor Replacement (Hot Unit)



1. Remove the brackets (two pieces, one left, one right). One Screw each.

2. Lift bottom shelf at the front. It is turnable.
3. Sensor is located at the back.
4. Sensor is screwed from the outside in.

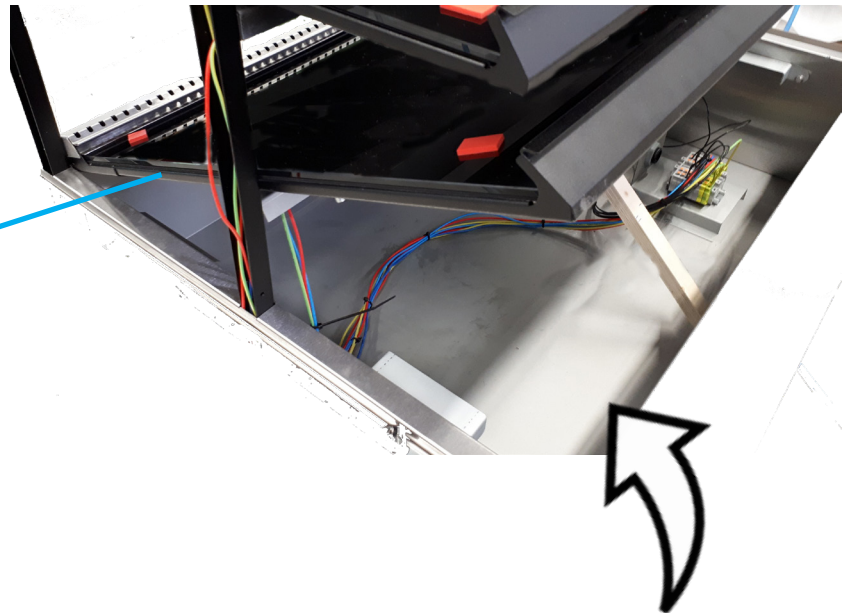
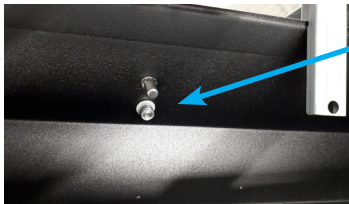

5. Remove glass pane from lowest shelf. (see 11.10).
6. Remove fan box. (see 11.9).
7. Unscrew the sensor holding plate.
8. Click sensor out of mounting bracket.
9. Place new sensor, put wiring in the same location as the old wiring.



12.7 Child glass replacement (When applicable)

1. Remove front panel (see 11.16).
2. Loosen mounting screws (3x) of child glass. Screwed from underneath
3. Place new child glass.
4. Mount in reverse order.



Mounting screws

12.8 MCC Air guide replacement

1. Air guide replacement
 2. For replacement, open top glass pane entirely.
-  Be aware of the weight of the glass.

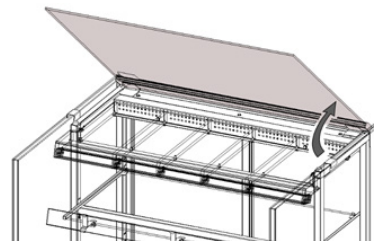

3. Remove the air guide by simply lifting them out.

HOT

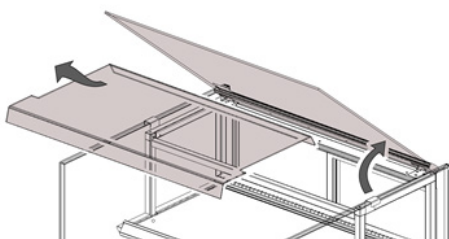

COLD

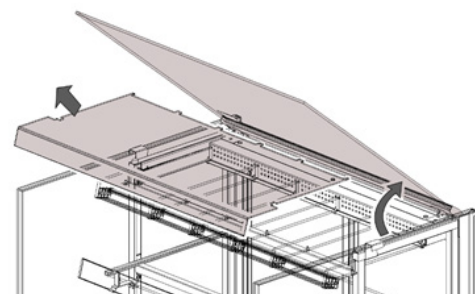

12.9 Fan box replacement



1. Remove air box cover (3 screws).

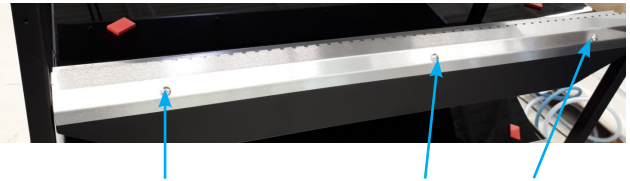

2. Remove glass pane clamp.
(4 or more bolts depending on unit length)

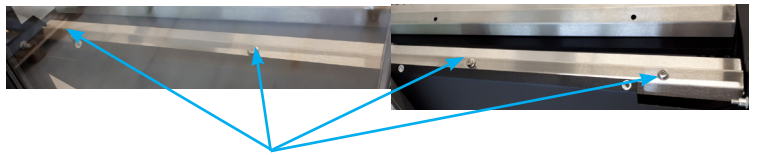

3. Remove Glass pane (refer 11.10).

4. Remove air box (1 connector, two screws).

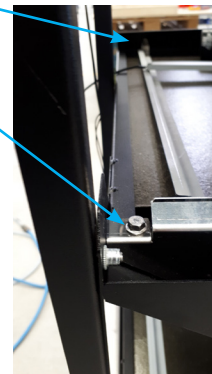
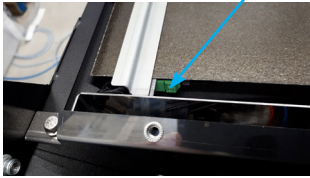

5. Replace in reverse order.



Note:

If replacement has to take place on a solid back unit, the back panel assembly must be removed before accessing the air box screws mentioned in step 1

12.10 Replacement of shelf glass pane



Each shelf is covered with a tempered glass pane.
To replace follow steps below:

1. Remove air outlet cover by removing the screws (depending on length three or more screws)

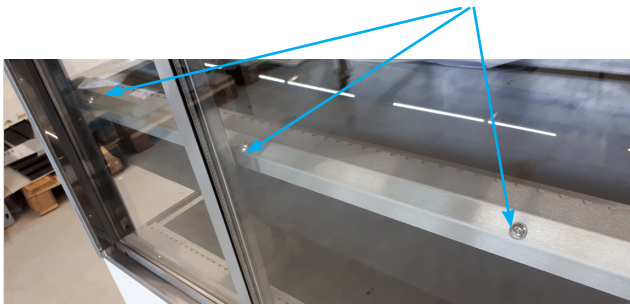

2. Remove glass mounting profile by removing the screws (depending on length three or more screws)

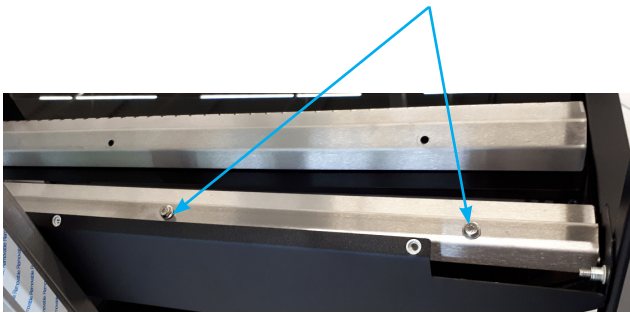

3. Lift out glass pane, starting lifting from the back. (Take care of glass holder strip on the front side of the glass)

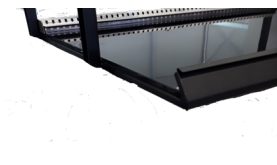
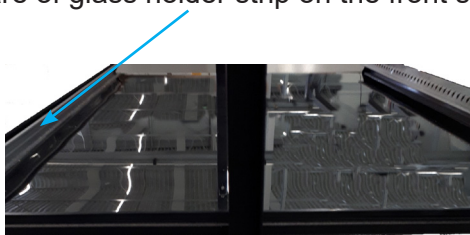

4. Take new glass pane, place front glass holder strip and place pane into position.

12.11 Opening Electrical box



Depending on the MCC version the electric box is placed at the back or in the front of the unit. For drop in versions the box can be placed anywhere in the build in counter.

First remove the panel (back or front depending on version)
Panel is fixed with two screws underneath the unit. Loosen those.

In some versions you also need to loosen the screws on the side of the under storage compartment.

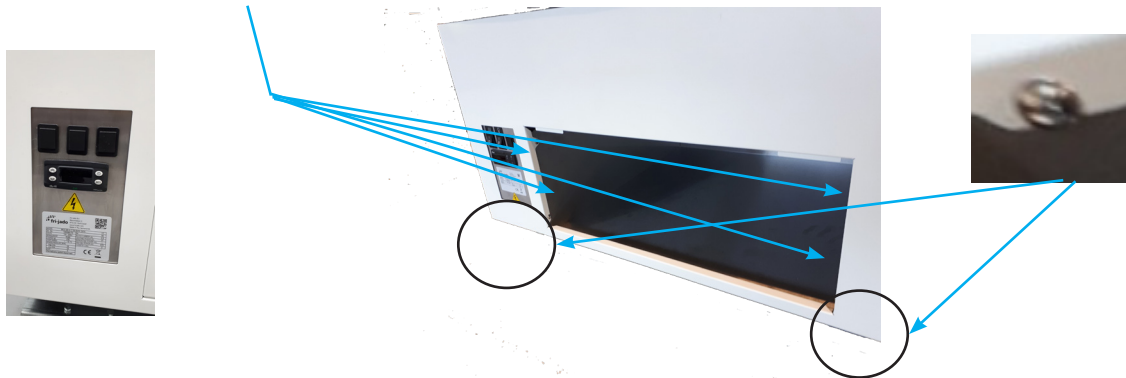

After loosening the screws, you can remove the panel by pulling it slightly down and then turning it towards you.

Two lips on the top of the panel, keep the panel in place.

Depending on the version you find one
Screw on top of the electrical box,
or two screws, underneath the pull
out handle from the box.

Remove those screws.

Now you can pull the box toward you.
The box will slide in its rails



Normal version (24V psu)



Special version (15V psu)
See serial number remarks in
parts section



12.12 Led light Replacement



All LED Lights are mounted in the same way.

1. Remove side glass panes. (Refer 7.2)
2. Remove column cover.
(two screws, one on top backside and one at the bottom back side)
3. Pull off column cover.
4. Remove screw holding the LED housing .
5. Disconnect connector in Column, before you do so, make a note of the placing of the red and black cable in the connector.
6. Take LED light out of LED light holder, and place new LED.
7. Connect the wires from the new LED in the column, taking care of the notes you made regarding the red and black cable.

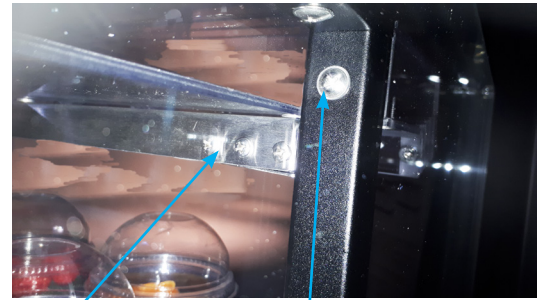

Column screw (top)

12.13 Heating element replacement



1. Remove Shelf Glass pane (refer 11.10)
2. Remove air box (refer 11.9).
3. Remove side glass (refer 11.2)
4. Remove column cover (middle left column cover, seen from back of unit).



- Loosen Element holders, depending on the version the holders are twisted at the back side, or fastened with screws.



- Take off the top element holders. Heating Element is now free to take out.



Make a note of the placement of the wiring.

- Take out element.

If possible, follow the wires going down in the column.
If not, cut the wire in the column, leaving enough length to make a connection to the wires from the new element.

NEVER make a connection underneath the heating element

Connect the wires in the column using a wago connector like the one on this picture:



Take care of connecting:



Red to Red,
Blue to Blue, and
Yellow to Yellow.

12.14 Controller Replacement



- Open Electric box (refer 11.11)
- Unscrew the brown and Blue wire (Make note of connection points)
- Unscrew the four black wires. (Make note of number and connection position)
- Using a flat screwdriver push out the controller to the front of the box
- Place new controller, by pushing it in.
- Connect wires again, to the marked positions (point 2 and 3)
- Check all parameter settings according the parameter list.(Chapter 9)



12.16 Panel Replacement

1. Remove Plinths (refer 4.8)

Front panel

1. Remove front panel, by removing the holding screws (left and right bottom corner)



Bottom view



2. Pull panel slightly towards you and down, to remove.
3. Replace in reverse order

Back panel

1. Remove back panel, by removing the holding screws (left and right bottom corner)



Bottom view



2. Pull panel slightly towards you and down, to remove.
3. Replace in reverse order

12-17 Front glass pane replacement (Full serve models)

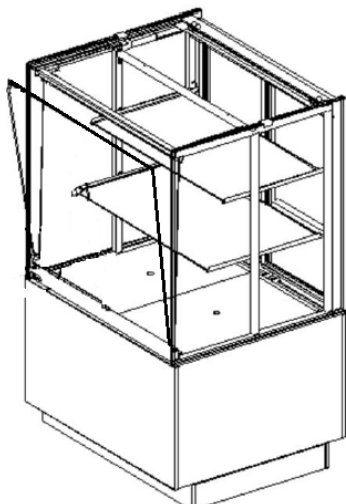
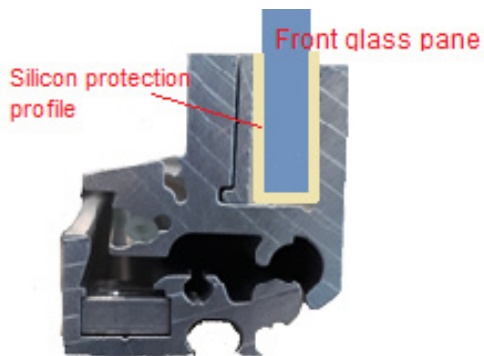

1. Lift top glass to "unlock" the front glass
2. Slightly turn the front glass towards you
3. In the right tilted position, you can take glass pane including profile out.
4. Replace in reverse order.

12.1 Hot Full serve element replacement

For the MCC 60 Hot Full Serve an other heating element is implemented.

Don't place the old element type any more.

Number for this kit is:

9382269s

Heating element 1500W 230V (packed)



Existing situation

New situation

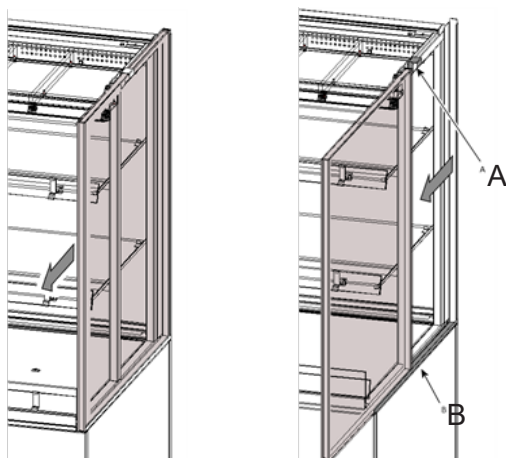

Step 1. Remove power plug from wall outlet.

Step 2.

For easy access, please remove both side glasses.

Slide the double glass pane towards the front along the top (A) and bottom (B) guiding rails.

The side pane can be removed from the unit once it has slid entirely past the top guide.

Before sliding the glass pane back into the rails, ensure the transparent sides of the pane are facing forwards and up.

Slide it all the way back till the front of the pane is in line with the front plating.

12.1 Hot Full serve element replacement

Step 3.

Remove bottom product plateau, both, left and right.

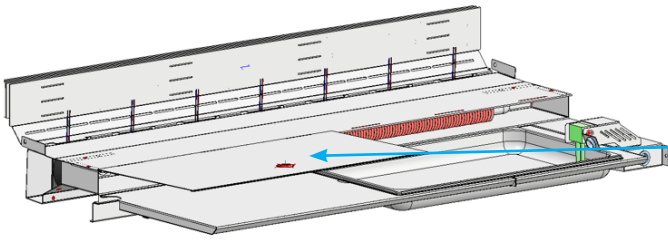

Step 4.

Remove cover deck, both left and right.

Step 5.

Remove GN pan, careful not to spill water.

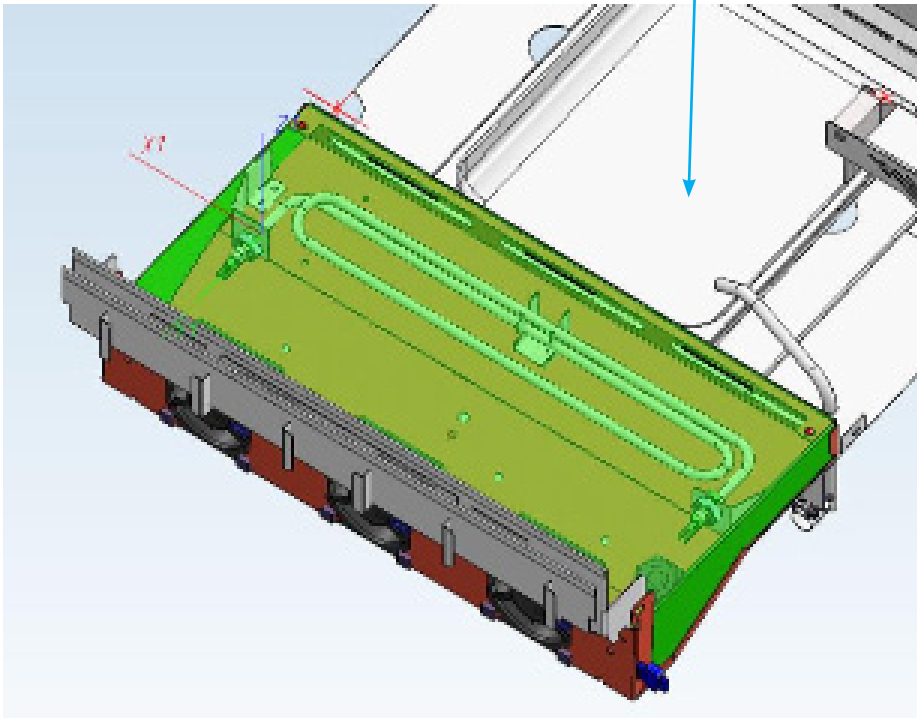

Step 6,

Remove top cover from heating element box 4 bolts.

Step 7.

Remove wire connection from element by removing the nut.



Step 8.

Remove old type heating element by removing the mounting nuts.

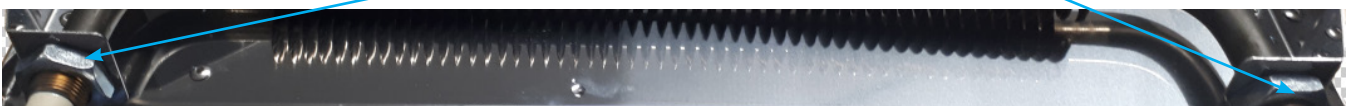

12.1 Hot Full serve element replacement

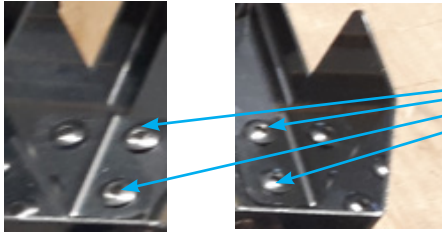

Step 9.

Remove rivet (4) by drilling them out, which are holding the heating element mounting brackets, both left and right.

Step 10.

Place new heating element holding brackets, and mount these with the bolts and nuts, as delivered.

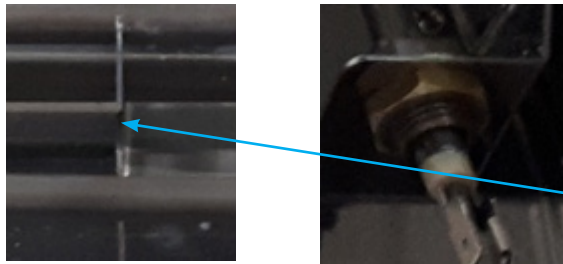

Step 11.

Place distance bracket on heating element (in the middle) and positioning the element in the new mounting holes.

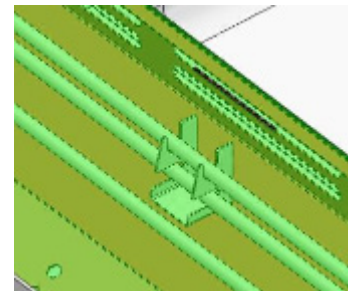
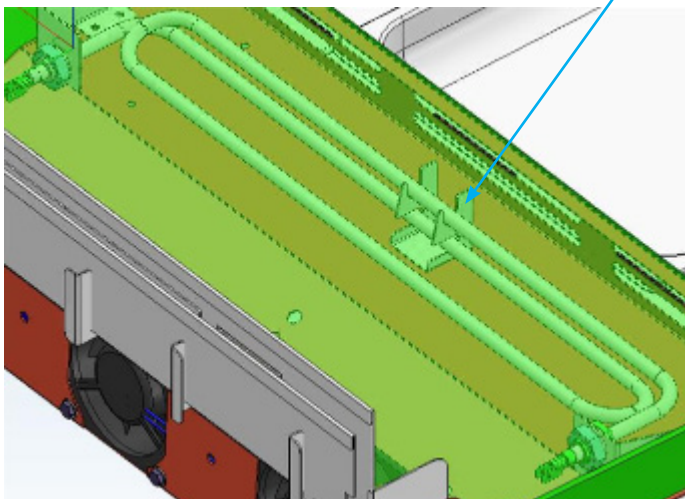

Step 12.

Mount the element in place using the delivered mounting nuts and gaskets. Tighten the nuts with wrench softly.

Step 13.

Cut fastons (ring type) from power wire and replace this by the newly delivered fastons (clamp type) perform this for both connections.

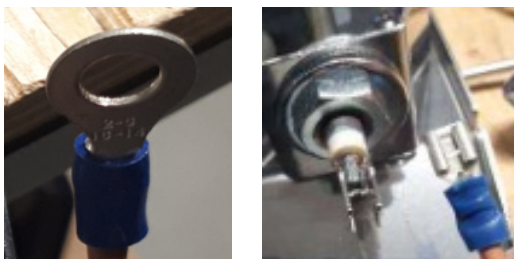

Step 14.

Connect power wires to the heating element with the newly connected fastons (clamp type)



12.1 Hot Full serve element replacement



Make sure after placement, the power wire is not between the blowers and the element.

Airflow should not be interrupted by the wire.

Wire under airflow from blower !

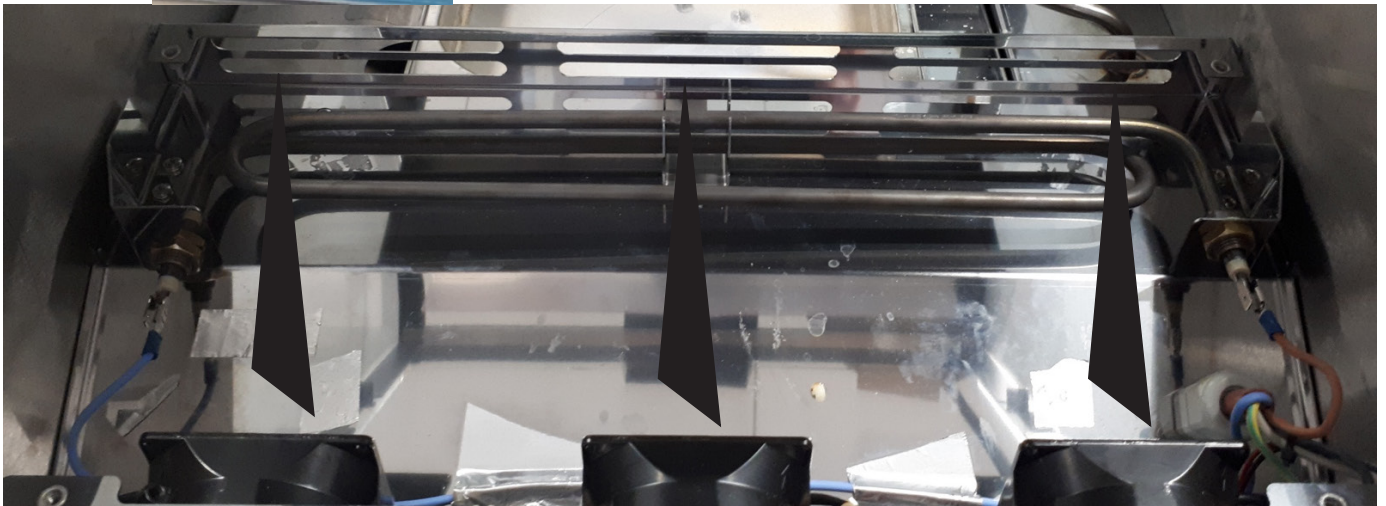

Step 15.

Close heating element cover (removed in step 6).

Step 16.

Close unit by replacing all parts removed during the first 5 steps, in reverse order.

Step 17.

Put power cord in wall outlet and test unit.



13.0 Technical Specifications MCC Hot - 2 (Full Serve) US

Specification	Unit	Model			
		24-2	36-2	48-2	60-2
General					
Length incl. end walls	"	23 5/8	35 7/16	47 1/4	n.a.
Length excl. end walls	"	21 5/8	33 7/16	45 1/4	n.a.
Depth	"	29 1/2			
Height on stand	"	29 1/2			n.a.
Height above worktop	"	20 1/2			n.a.
Underframe height	"	35 7/16			n.a.
Plinth height	"	3 15/16			n.a.
Drop-in cut out (W x D)	"	22 5/16 x 28 9/16 (+/- 3/16)	34 1/8 x 28 9/16 (+/- 3/16)	45 15/16 x 28 9/16 (+/- 3/16)	n.a.
Electronics panel cut out (L x H)	"	6 x 9 5/8 (+/- 3/16)			
Weight (net)	lbs	243	320	397	n.a.
Weight (gross)	lbs	298	390	481	n.a.
Packaging dimensions (W x D x H)	"	28 3/8 x 34 1/4 x 57 1/2	40 3/16 x 34 1/4 x 57 1/2	51 15/16 x 34 1/4 x 57 1/2	
Nr. of presentation levels		2			n.a.
Dimensions bottom shelf	"	23 1/4 x 19 11/16	23 1/4 x 31 1/2	23 1/4 x 43 5/16	n.a.
Dimensions top shelf	"	19 5/16 x 19 11/16	19 5/16 x 31 1/2	19 5/16 x 43 5/16	n.a.
Shelf display area	ft2	5,81	9,26	12,81	n.a.
Usable display volume	ft3	5,44	7,27	9,99	n.a.

Specification	Unit	Model			
		24-2	36-2	48-2	60-2
Performance					
TDA*	ft2	7,10	10,66	14,32	n.a.
TEC at climate class 0*	BTU/h	2730	4095	5494	n.a.
TEC at climate class 0*	BTU/day	65411	98099	131777	n.a.
TEC/TDA at climate class 0*	BTU/day/ft2	9206			
Sound pressure	dB(A)	<70			n.a.
Minimum ambient temperature	°F	68			n.a.
Maximum ambient temperature	°F	86			n.a.
Maximum relative air humidity	%	60			n.a.

* According to ISO 23953

Specification	Unit	Model			
		24-2	36-2	48-2	60-2
Electrical					
Electrical connection		NEMA 6-20P*			n.a.
Nominal voltage	V	1~ 208			n.a.
Nominal frequency	Hz	50/60			n.a.
Maximum power	W	1715	2080	2774	n.a.
Nominal current	A	6,2	9,3	12,4	n.a.
Required fuses		1 x 16A			n.a.
Heating fan power	W	36	60	84	n.a.
Nr. of heating fans		3	5	7	n.a.
Heating element power	W	1500 (-0/+10%)	1800 (-0/+10%)	2400 (-0/+10%)	n.a.
LED lighting power	W	14	25	35	n.a.

* Standard plug

13.1 MCC 90 Drop-in Dimensions Self Serve

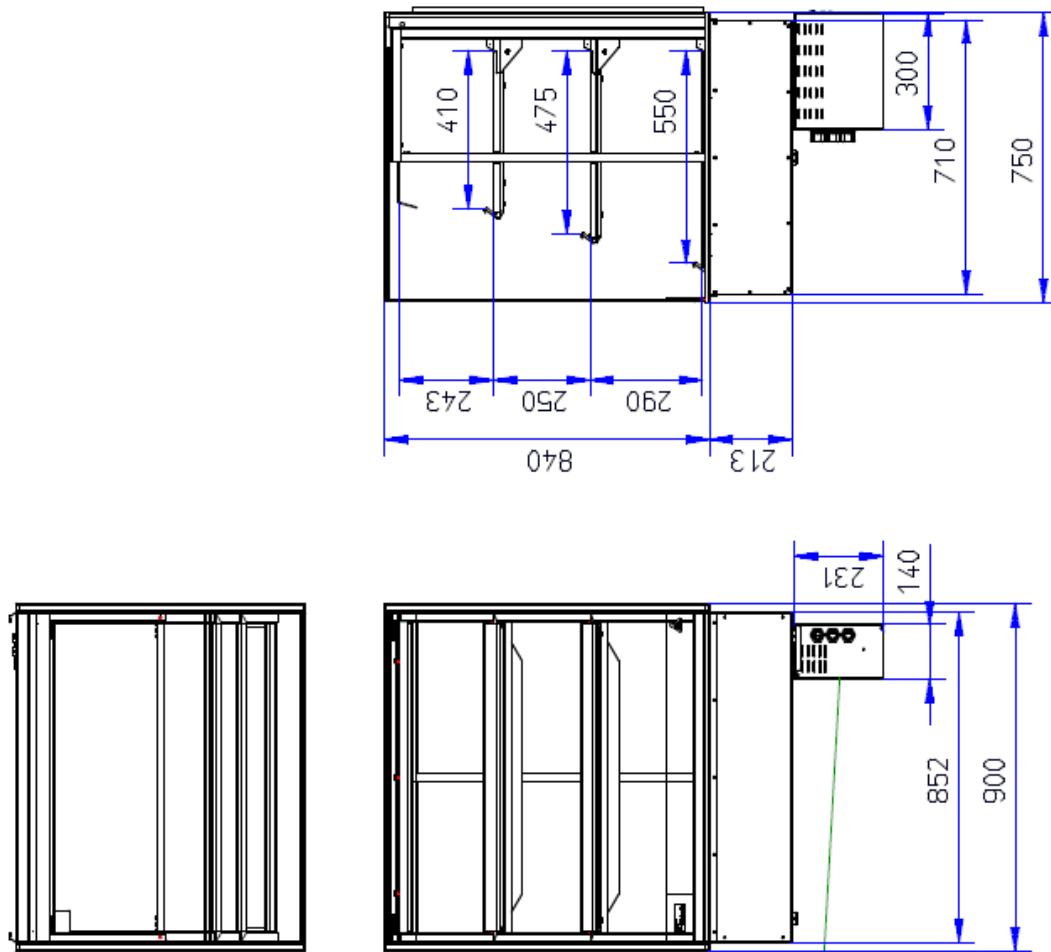

Control box can be mounted remotely up to 1 meter from indicated position

Allow cut-out for drop-in: 867x725 (+/- 5)
Please refer to installation manual

13.2 Technical Specifications MCC Hot - 2 (Self Serve) US

Specification	Unit	Model			
		24-2	36-2	48-2	60-2
General					
Length incl. end walls	"	23 5/8	35 7/16	47 1/4	n.a.
Length excl. end walls	"	21 5/8	33 7/16	45 1/4	n.a.
Depth	"		29 1/2		n.a.
Height on stand	"		29 1/2		n.a.
Height above worktop	"		20 1/2		n.a.
Underframe height	"		35 7/16		n.a.
Plinth height	"		3 15/16		n.a.
Drop-in cut out (W x D)	"	22 5/16 x 28 9/16 (+/- 3/16)	34 1/8 x 28 9/16 (+/- 3/16)	45 15/16 x 28 9/16 (+/- 3/16)	n.a.
Electronics panel cut out (L x H)	"	6 x 9 5/8 (+/- 3/16)			n.a.
Weight (net)	lbs	243	320	397	n.a.
Weight (gross)	lbs	298	390	481	n.a.
Packaging dimensions (W x D x H)	"	28 3/8 x 34 1/4 x 57 1/2	40 3/16 x 34 1/4 x 57 1/2	51 15/16 x 34 1/4 x 57 1/2	n.a.
Nr. of presentation levels		2			n.a.
Dimensions bottom shelf	"	21 5/8 x 19 11/16	21 5/8 x 31 1/2	21 5/8 x 43 5/16	n.a.
Dimensions top shelf	"	18 11/16 x 19 11/16	18 11/16 x 31 1/2	18 11/16 x 43 5/16	n.a.
Shelf display area	ft2	5,49	8,83	12,16	n.a.
Usable display volume	ft3	3,28	5,26	7,24	n.a.

Specification	Unit	Model			
		24-2	36-2	48-2	60-2
Performance					
TDA*	ft2	7,10	10,66	14,32	n.a.
TEC at climate class 0*	BTU/h	3173	4743	6381	n.a.
TEC at climate class 0*	BTU/day	75954	113897	153035	n.a.
TEC/TDA at climate class 0*	BTU/day/ft2	10689			n.a.
Sound pressure	dB(A)	<70			n.a.
Minimum ambient temperature	°F	68			n.a.
Maximum ambient temperature	°F	86			n.a.
Maximum relative air humidity	%	60			n.a.

* According to ISO 23953

Specification	Unit	Model			
		24-2	36-2	48-2	60-2
Electrical					
Electrical connection		NEMA 6-20P*			n.a.
Nominal voltage	V	1~ 208			n.a.
Nominal frequency	Hz	50/60			n.a.
Maximum power	W	1561	2209	2943	n.a.
Nominal current	A	7,1	10,1	13,4	n.a.
Required fuses		1 x 20A			n.a.
Heating fan power	W	7	11	15	n.a.
Nr. of heating fans		4	6	8	n.a.
Heating element bottom shelf power	W	750 (-0/+10%)	1125 (-0/+10%)	1500 (-0/+10%)	n.a.
Heating element top shelf power	W	650 (-0/+10%)	850 (-0/+10%)	1130 (-0/+10%)	n.a.
LED lighting power	W	14	25	35	n.a.

* Standard plug

13.3 MCC Hot Drop-in Specifications Self Serve

Specification	Unit	Model			
		60-3	90-3	120-3	150-3
General					
Length incl. end walls	mm	n.a.	900	1200	1500
Length excl. end walls	mm	n.a.	850	1150	1450
Depth	mm	n.a.		750	
Height on stand	mm	n.a.		1420	
Height above worktop	mm	n.a.		840	
Underframe height	mm	n.a.		580	
Plinth height	mm	n.a.		100	
Drop-in cut out (W x D)	mm	n.a.	867 x 725 (+/- 5)	1167 x 725 (+/- 5)	1467 x 725 (+/- 5)
Electronics panel cut out (W x H)	mm	n.a.		153 x 244 (+/- 5)	
Weight (net)	kg	n.a.	175	202	229
Weight (gross)	kg	n.a.	207	240	273
Packaging dimensions (W x D x H)	mm	n.a.	1020 x 870 x 1460	1320 x 870 x 1460	1620 x 870 x 1460
Nr. of presentation levels		n.a.		3	
Dimensions bottom shelf	mm	n.a.	590 x 800	590 x 1100	590 x 1400
Dimensions middle shelf	mm	n.a.	475 x 800	475 x 1100	475 x 1400
Dimensions top shelf	mm	n.a.	410 x 800	410 x 1100	410 x 1400
Shelf display area	m ²	n.a.	1,18	1,62	2,07
Usable display volume	l	n.a.	258	355	452
Drain diameter	mm	n.a.		32	
Minimum room floor area	m ²	n.a.	11,00	14,35	17,70
Minimum air inlet surface area	cm ²	n.a.	1100		1250
Minimum air outlet surface area	cm ²	n.a.	500	700	900

Specification	Unit	Model			
		60-3	90-3	120-3	150-3
Performance					
Climate class*		n.a.		3	
Classification*		n.a.		M1	
TDA*	m ²	n.a.	1,18	1,60	2,02
TEC at 3M1*	kWh/day	n.a.	12,8	t.b.d.	t.b.d.
TEC/TDA at 3M1*	kWh/day/m ²	n.a.	10,85	t.b.d.	t.b.d.
Energy class at 3M1*		n.a.	E	t.b.d.	t.b.d.
TEW/†**	kg of CO ₂	n.a.	27023	t.b.d.	t.b.d.
Sound pressure	dB(A)	n.a.		<70	
Minimum ambient temperature	°C	n.a.		17	
Maximum ambient temperature	°C	n.a.		25	
Maximum relative air humidity	%	n.a.		60	

* According to ISO 23953, open front, test type 1 (24 hours without night cover)

** Total equivalent warming impact according to EN 378, based on 10 years of operation at climate class 3, 0,295 kg CO₂/kWh and a leakage rate of 1% per year

13.4 Technical Specifications MCC Hot - 3 (Full Serve) US

Specification	Unit	Model			
		24-3	36-3	48-3	60-3
General					
Length incl. end walls	"	23 5/8	35 7/16	47 1/4	n.a.
Length excl. end walls	"	21 5/8	33 7/16	45 1/4	n.a.
Depth	"	29 1/2			n.a.
Height on stand	"	55 7/8			n.a.
Height above worktop	"	33 1/16			n.a.
Underframe height	"	22 13/16			n.a.
Plinth height	"	3 15/16			n.a.
Drop-in cut out (W x D)	"	22 5/16 x 28 9/16 (+/- 3/16)	34 1/8 x 28 9/16 (+/- 3/16)	45 15/16 x 28 9/16 (+/- 3/16)	n.a.
Electronics panel cut out (L x H)	"	6 x 9 5/8 (+/- 3/16)			n.a.
Weight (net)	lbs	298	375	452	n.a.
Weight (gross)	lbs	355	445	536	n.a.
Packaging dimensions (W x D x H)	"	28 3/8 x 34 1/4 x 57 1/2	40 3/16 x 34 1/4 x 57 1/2	51 15/16 x 34 1/4 x 57 1/2	n.a.
Nr. of presentation levels		3			n.a.
Dimensions bottom shelf	"	23 1/4 x 19 11/16	23 1/4 x 31 1/2	23 1/4 x 43 5/16	n.a.
Dimensions middle shelf	"	19 5/16 x 19 11/16	19 5/16 x 31 1/2	19 5/16 x 43 5/16	n.a.
Dimensions top shelf	"	16 3/4 x 19 11/16	16 3/4 x 31 1/2	16 3/4 x 43 5/16	n.a.
Shelf display area	ft ²	8,07	12,92	17,87	n.a.
Usable display volume	ft ³	5,69	9,11	12,54	n.a.

Specification	Unit	Model			
		24-3	36-3	48-3	60-3
Performance					
TDA*	ft ²	8,40	13,02	17,65	n.a.
TEC at climate class 0*	BTU/h	3207	4982	6790	n.a.
TEC at climate class 0*	BTU/day	77285	119937	162554	n.a.
TEC/TDA at climate class 0*	BTU/day/ft ²	9212			n.a.
Sound pressure	dB(A)	<70			n.a.
Minimum ambient temperature	°F	68			n.a.
Maximum ambient temperature	°F	86			n.a.
Maximum relative air humidity	%	60			n.a.

* According to ISO 23953

Specification	Unit	Model			
		24-3	36-3	48-3	60-3
Electrical					
Electrical connection		NEMA 6-20P*			n.a.
Nominal voltage	V	1~ 208			n.a.
Nominal frequency	Hz	50/60			n.a.
Maximum power	W	1722	2092	2792	n.a.
Nominal current	A	7,8	9,4	12,7	n.a.
Required fuses		1 x 20A			n.a.
Heating fan power	W	36	60	84	n.a.
Nr. of heating fans		3	5	7	n.a.
Heating element power	W	1500 (-0/+10%)	1800 (-0/+10%)	2400 (-0/+10%)	n.a.
LED lighting power	W	21	37	53	n.a.

* Standard plug

13.5 Technical Specifications MCC Hot - 3 (Self Serve) US

Specification	Unit	Model			
		24-3	36-3	48-3	60-3
General					
Length incl. end walls	"	23 5/8	35 7/16	47 1/4	n.a.
Length excl. end walls	"	21 5/8	33 7/16	45 1/4	n.a.
Depth	"	29 1/2			n.a.
Height on stand	"	55 7/8			n.a.
Height above worktop	"	33 1/16			n.a.
Underframe height	"	22 13/16			n.a.
Plinth height	"	3 15/16			n.a.
Drop-in cut out (W x D)	"	22 5/16 x 28 9/16 (+/- 3/16)	34 1/8 x 28 9/16 (+/- 3/16)	45 15/16 x 28 9/16 (+/- 3/16)	n.a.
Electronics panel cut out (L x H)	"	6 x 9 5/8 (+/- 3/16)			n.a.
Weight (net)	lbs	298	375	452	n.a.
Weight (gross)	lbs	355	445	536	n.a.
Packaging dimensions (W x D x H)	"	28 3/8 x 34 1/4 x 57 1/2	40 3/16 x 34 1/4 x 57 1/2	51 15/16 x 34 1/4 x 57 1/2	n.a.
Nr. of presentation levels		3			n.a.
Dimensions bottom shelf	"	21 5/8 x 19 11/16	21 5/8 x 31 1/2	21 5/8 x 43 5/16	n.a.
Dimensions middle shelf	"	18 11/16 x 19 11/16	18 11/16 x 31 1/2	18 11/16 x 43 5/16	n.a.
Dimensions top shelf	"	16 1/8 x 19 11/16	16 1/8 x 31 1/2	16 1/8 x 43 5/16	n.a.
Shelf display area	ft ²	7,75	12,38	17,01	n.a.
Usable display volume	ft ³	4,59	7,31	10,06	n.a.

Specification	Unit	Model			
		24-3	36-3	48-3	60-3
Performance					
TDA*	ft ²	8,40	13,02	17,65	n.a.
TEC at climate class 0*	BTU/h	3753	5801	7848	n.a.
TEC at climate class 0*	BTU/day	89739	139215	188691	n.a.
TEC/TDA at climate class 0*	BTU/day/ft ²	10689			n.a.
Sound pressure	dB(A)	<70			n.a.
Minimum ambient temperature	°F	68			n.a.
Maximum ambient temperature	°F	86			n.a.
Maximum relative air humidity	%	60			n.a.

* According to ISO 23953

Specification	Unit	Model			
		24-3	36-3	48-3	60-3
Electrical					
Electrical connection		NEMA 6-20P*		NEMA 15-20P*	n.a.
Nominal voltage	V	1~ 208		3~ 208	n.a.
Nominal frequency	Hz	50/60			n.a.
Maximum power	W	2099	3011	4011	n.a.
Nominal current	A	9,5	13,7	13,5	n.a.
Required fuses		1 x 20A		3 x 20A	n.a.
Heating fan power	W	11	16	22	n.a.
Nr. of heating fans (total)		6	9	12	n.a.
Heating element bottom shelf power	W	750 (-0/+10%)	1125 (-0/+10%)	1500 (-0/+10%)	n.a.
Heating element middle shelf power	W	650 (-0/+10%)	850 (-0/+10%)	1130 (-0/+10%)	n.a.
Heating element top shelf power	W	465 (-0/+10%)	700 (-0/+10%)	935 (-0/+10%)	n.a.
LED lighting power	W	21	37	53	n.a.

* Standard plug

13.6 Technical Specifications MCC Hot (Self Serve) Humidified US

Specification	Unit	Model			
		24-3	36-3	48-3	60-3
General					
Length incl. end walls	"	23 5/8	35 7/16	47 1/4	n.a.
Length excl. end walls	"	21 5/8	33 7/16	45 1/4	n.a.
Depth	"	29 1/2			n.a.
Height on stand	"	55 7/8			n.a.
Height above worktop	"	33 1/16			n.a.
Underframe height	"	22 13/16			n.a.
Plinth height	"	3 15/16			n.a.
Drop-in cut out (W x D)	"	22 5/16 x 28 9/16 (+/- 3/16)	34 1/8 x 28 9/16 (+/- 3/16)	45 15/16 x 28 9/16 (+/- 3/16)	n.a.
Electronics panel cut out (L x H)	"	6 x 9 5/8 (+/- 3/16)			n.a.
Weight (net)	lbs	298	375	452	n.a.
Weight (gross)	lbs	355	445	536	n.a.
Packaging dimensions (W x D x H)	"	28 3/8 x 34 1/4 x 57 1/2	40 3/16 x 34 1/4 x 57 1/2	51 15/16 x 34 1/4 x 57 1/2	n.a.
Nr. of presentation levels		3			n.a.
Dimensions bottom shelf	"	23 1/4 x 19 11/16	23 1/4 x 31 1/2	23 1/4 x 43 5/16	n.a.
Dimensions middle shelf	"	19 5/16 x 19 11/16	19 5/16 x 31 1/2	19 5/16 x 43 5/16	n.a.
Dimensions top shelf	"	16 3/4 x 19 11/16	16 3/4 x 31 1/2	16 3/4 x 43 5/16	n.a.
Shelf display area	ft2	8,07	12,92	17,87	n.a.
Usable display volume	ft3	5,69	9,11	12,54	n.a.

Specification	Unit	Model			
		24-3	36-3	48-3	60-3
Performance					
TDA*	ft2	8,40	13,02	17,65	n.a.
TEC at climate class 0*	BTU/h	3207	4982	6790	n.a.
TEC at climate class 0*	BTU/day	77285	119937	162554	n.a.
TEC/TDA at climate class 0*	BTU/day/ft2	9212			n.a.
Sound pressure	dB(A)	<70			n.a.
Minimum ambient temperature	*F	68			n.a.
Maximum ambient temperature	*F	86			n.a.
Maximum relative air humidity	%	60			n.a.

* According to ISO 23953

Specification	Unit	Model			
		24-3	36-3	48-3	60-3
Electrical					
Electrical connection		NEMA 6-20P*			n.a.
Nominal voltage	V	1~ 208			n.a.
Nominal frequency	Hz	50/60			n.a.
Maximum power	W	1722	2092	2792	n.a.
Nominal current	A	7,8	9,4	12,7	n.a.
Required fuses		1 x 20A			n.a.
Heating fan power	W	36	60	84	n.a.
Nr. of heating fans		3	5	7	n.a.
Heating element power	W	1500 (-0/+10%)	1800 (-0/+10%)	2400 (-0/+10%)	n.a.
LED lighting power	W	21	37	53	n.a.

* Standard plug

13.7 Technical Specifications MCC Hot - 4 (Full Serve) US

Specification	Unit	Model			
		24-4	36-4	48-4	60-4
General					
Length incl. end walls	"	23 5/8	35 7/16	47 1/4	n.a.
Length excl. end walls	"	21 5/8	33 7/16	45 1/4	n.a.
Depth	"	29 1/2			n.a.
Height on stand	"	55 7/8			n.a.
Height above worktop	"	33 1/16			n.a.
Underframe height	"	22 13/16			n.a.
Plinth height	"	3 15/16			n.a.
Drop-in cut out (W x D)	"	22 5/16 x 28 9/16 (+/- 3/16)	34 1/8 x 28 9/16 (+/- 3/16)	45 15/16 x 28 9/16 (+/- 3/16)	n.a.
Electronics panel cut out (L x H)	"	6 x 9 5/8 (+/- 3/16)			n.a.
Weight (net)	lbs	309	390	472	n.a.
Weight (gross)	lbs	366	461	556	n.a.
Packaging dimensions (W x D x H)	"	28 3/8 x 34 1/4 x 57 1/2	40 3/16 x 34 1/4 x 57 1/2	51 15/16 x 34 1/4 x 57 1/2	n.a.
Nr. of presentation levels		4			n.a.
Dimensions bottom shelf	"	23 1/4 x 19 11/16	23 1/4 x 31 1/2	23 1/4 x 43 5/16	n.a.
Dimensions middle shelves	"	19 5/16 x 19 11/16	19 5/16 x 31 1/2	19 5/16 x 43 5/16	n.a.
Dimensions top shelf	"	16 3/4 x 19 11/16	16 3/4 x 31 1/2	16 3/4 x 43 5/16	n.a.
Shelf display area	ft ²	10,76	17,22	23,57	n.a.
Usable display volume	ft ³	5,51	8,79	12,11	n.a.

Specification	Unit	Model			
		24-4	36-4	48-4	60-4
Performance					
TDA*	ft ²	8,40	13,02	17,65	n.a.
TEC at climate class 0*	BTU/h	3207	4982	6790	n.a.
TEC at climate class 0*	BTU/day	77285	119937	162554	n.a.
TEC/TDA at climate class 0*	BTU/day/ft ²	9212			n.a.
Sound pressure	dB(A)	<70			n.a.
Minimum ambient temperature	°F	68			n.a.
Maximum ambient temperature	°F	86			n.a.
Maximum relative air humidity	%	60			n.a.

* According to ISO 23953

Specification	Unit	Model			
		24-4	36-4	48-4	60-4
Electrical					
Electrical connection		NEMA 6-20P*			n.a.
Nominal voltage	V	1~ 208			n.a.
Nominal frequency	Hz	50/60			n.a.
Maximum power	W	1729	2104	2810	n.a.
Nominal current	A	7,8	9,5	12,8	n.a.
Required fuses		1 x 20A			n.a.
Heating fan power	W	36	60	84	n.a.
Nr. of heating fans		3	5	7	n.a.
Heating element power	W	1500 (-0/+10%)	1800 (-0/+10%)	2400 (-0/+10%)	n.a.
LED lighting power	W	28	49	71	n.a.

* Standard plug

13.8 Technical Specifications MCC Hot - 4 (Self Serve) Humidified US

Specification	Unit	Model			
		24-4	36-4	48-4	60-4
General					
Length incl. end walls	"	23 5/8	35 7/16	47 1/4	n.a.
Length excl. end walls	"	21 5/8	33 7/16	45 1/4	n.a.
Depth	"	29 1/2			n.a.
Height on stand	"	55 7/8			n.a.
Height above worktop	"	33 1/16			n.a.
Underframe height	"	22 13/16			n.a.
Plinth height	"	3 15/16			n.a.
Drop-in cut out (W x D)	"	22 5/16 x 28 9/16 (+/- 3/16)	34 1/8 x 28 9/16 (+/- 3/16)	45 15/16 x 28 9/16 (+/- 3/16)	n.a.
Electronics panel cut out (L x H)	"	6 x 9 5/8 (+/- 3/16)			n.a.
Weight (net)	lbs	309	390	472	n.a.
Weight (gross)	lbs	366	461	556	n.a.
Packaging dimensions (W x D x H)	"	28 3/8 x 34 1/4 x 57 1/2	40 3/16 x 34 1/4 x 57 1/2	51 15/16 x 34 1/4 x 57 1/2	n.a.
Nr. of presentation levels		4			n.a.
Dimensions bottom shelf	"	23 1/4 x 19 11/16	23 1/4 x 31 1/2	23 1/4 x 43 5/16	n.a.
Dimensions middle shelves	"	19 5/16 x 19 11/16	19 5/16 x 31 1/2	19 5/16 x 43 5/16	n.a.
Dimensions top shelf	"	16 3/4 x 19 11/16	16 3/4 x 31 1/2	16 3/4 x 43 5/16	n.a.
Shelf display area	ft ²	10,76	17,22	23,57	n.a.
Usable display volume	ft ³	5,51	8,79	12,11	n.a.

Specification	Unit	Model			
		24-4	36-4	48-4	60-4
Performance					
TDA*	ft ²	8,40	13,02	17,65	n.a.
TEC at climate class 0*	BTU/h	3207	4982	6790	n.a.
TEC at climate class 0*	BTU/day	77285	119937	162554	n.a.
TEC/TDA at climate class 0*	BTU/day/ft ²	9212			n.a.
Sound pressure	dB(A)	<70			n.a.
Minimum ambient temperature	°F	68			n.a.
Maximum ambient temperature	°F	86			n.a.
Maximum relative air humidity	%	60			n.a.

* According to ISO 23953

Specification	Unit	Model			
		24-4	36-4	48-4	60-4
Electrical					
Electrical connection		NEMA 6-20P*			n.a.
Nominal voltage	V	1~ 208			n.a.
Nominal frequency	Hz	50/60			n.a.
Maximum power	W	1729	2104	2810	n.a.
Nominal current	A	7,8	9,5	12,8	n.a.
Required fuses		1 x 20A			n.a.
Heating fan power	W	36	60	84	n.a.
Nr. of heating fans		3	5	7	n.a.
Heating element power	W	1500 (-0/+10%)	1800 (-0/+10%)	2400 (-0/+10%)	n.a.
LED lighting power	W	28	49	71	n.a.

* Standard plug

13.9 Explanation difference in levels and shelves

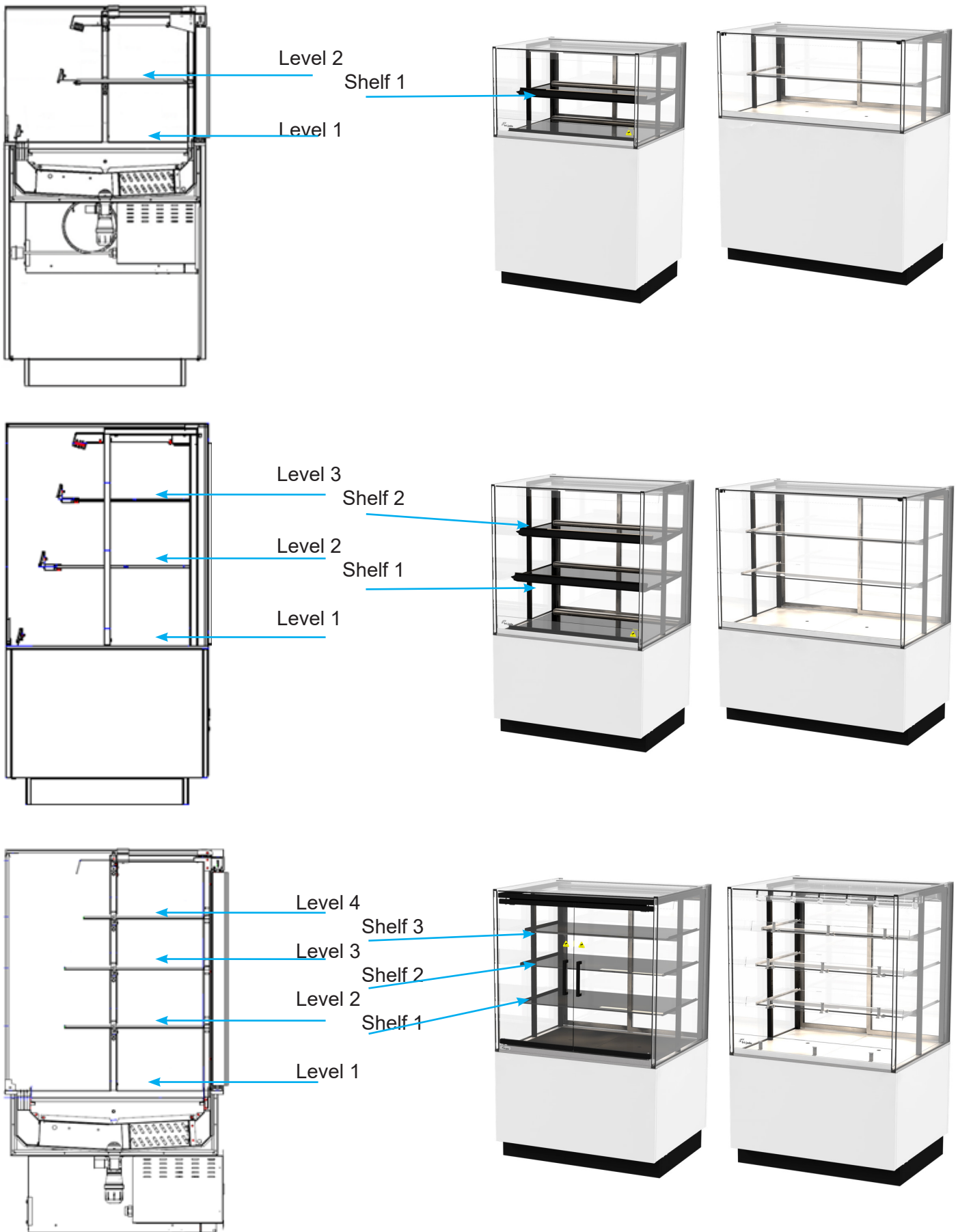

14.0 Exploded view MCC Hot 2 Level

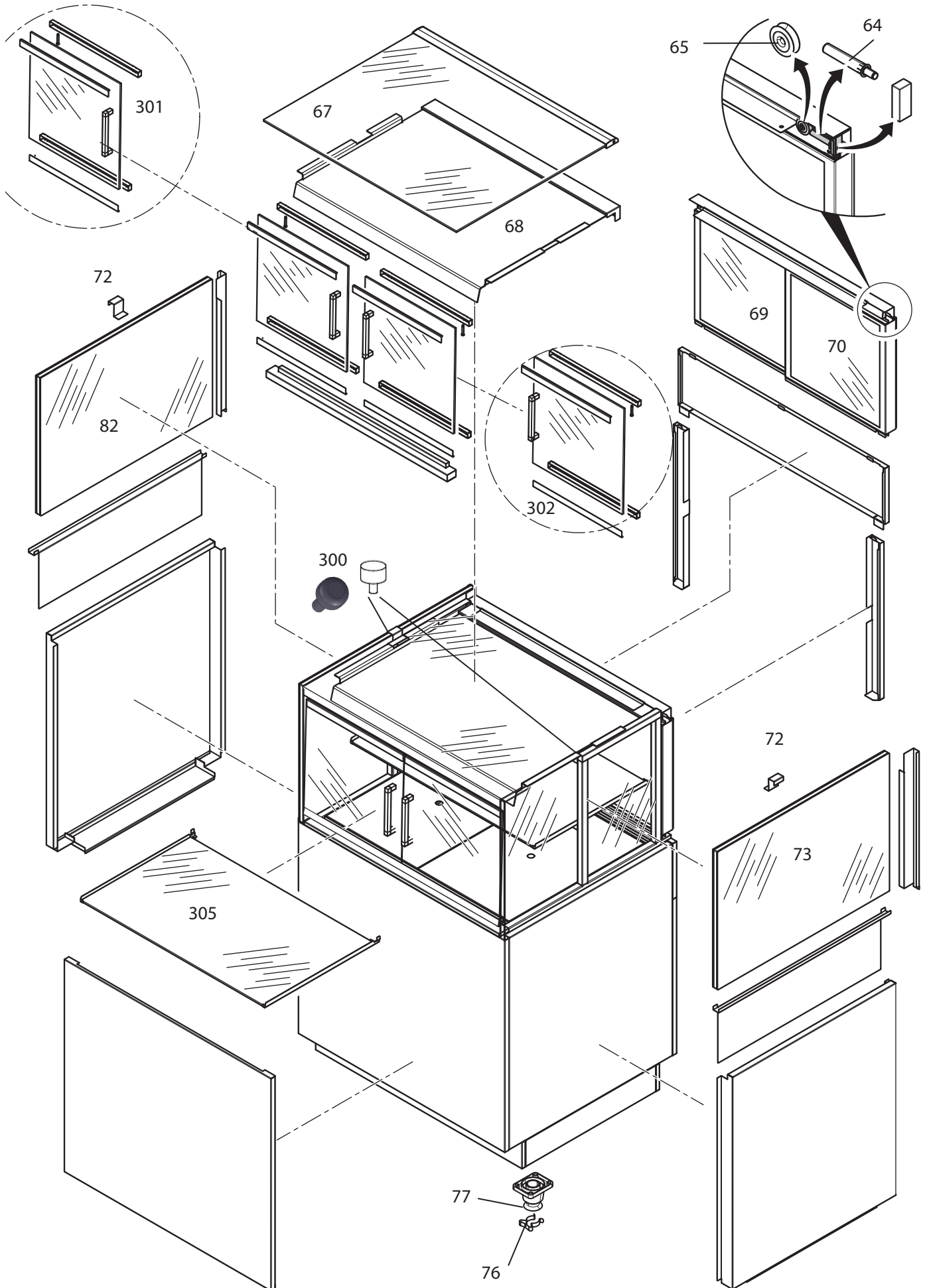

14.0 Exploded view MCC Hot 2 Level

Number	Description	Article number	Quantity
64	Soft close damper 3N	9281078	4
65	Steel roller bearing	9382100	4
67	Top Glass Square MCC 24 SS Top Glass Square MCC 36 SS Top Glass Square MCC 48 SS	9382165s 9382164s 9382166s	1 1 1
68	Air guide MCC 24 Air guide MCC 36 Air guide MCC 48	9382062 9382061 9382063	1 1 1
69	Assy Glass sliding door 24 Right Assy Glass sliding door 36 Right Assy Glass sliding door 48 Right	9380764 9380766 9380768	1 1 1
70	Assy Glass sliding door 24 Left Assy Glass sliding door 36 Left Assy Glass sliding door 48 Left	9380765 9380767 9380769	1 1 1
72	Side glass topside bracket	9384201	1
73	Side glass MCC 2 level see 82	9382750s	2
76	Tool-clamp	8071090	1
77	Adjustable leg	9291162	4
82	Side glass MCC 2 level see 73	9382750s	2
300	Plug top glass-pane (White) Plug top glass-pane (Black)	9263022 9381046	2 2
301	Assy. Front door Right MCC 36 2 level Assy. Front door Right MCC 48 2 level Assy. Front door Right MCC 60 2 level	9380585s 9380586s 9380587s seen from customer side	1 1 1
302	Assy. Front door Left MCC 24 2 level Assy. Front door Left MCC 36 2 level Assy. Front door Left MCC 48 2 level Assy. Front door Left MCC 60 2 level	9380581s 9380582s 9380583s 9380584s seen from customer side	1 1 1 1
	Set Hinge screws for one door 	30135910	1 p
305	Shelf glass MCC 24 Shelf glass MCC 36 Shelf glass MCC 48	9382036s 9382140s 9382081s	1 1 1
801	Screw top hinge, Screws countersunk M4x6	0141335	3 per hinge

14.1 Exploded view MCC Hot 2 Level

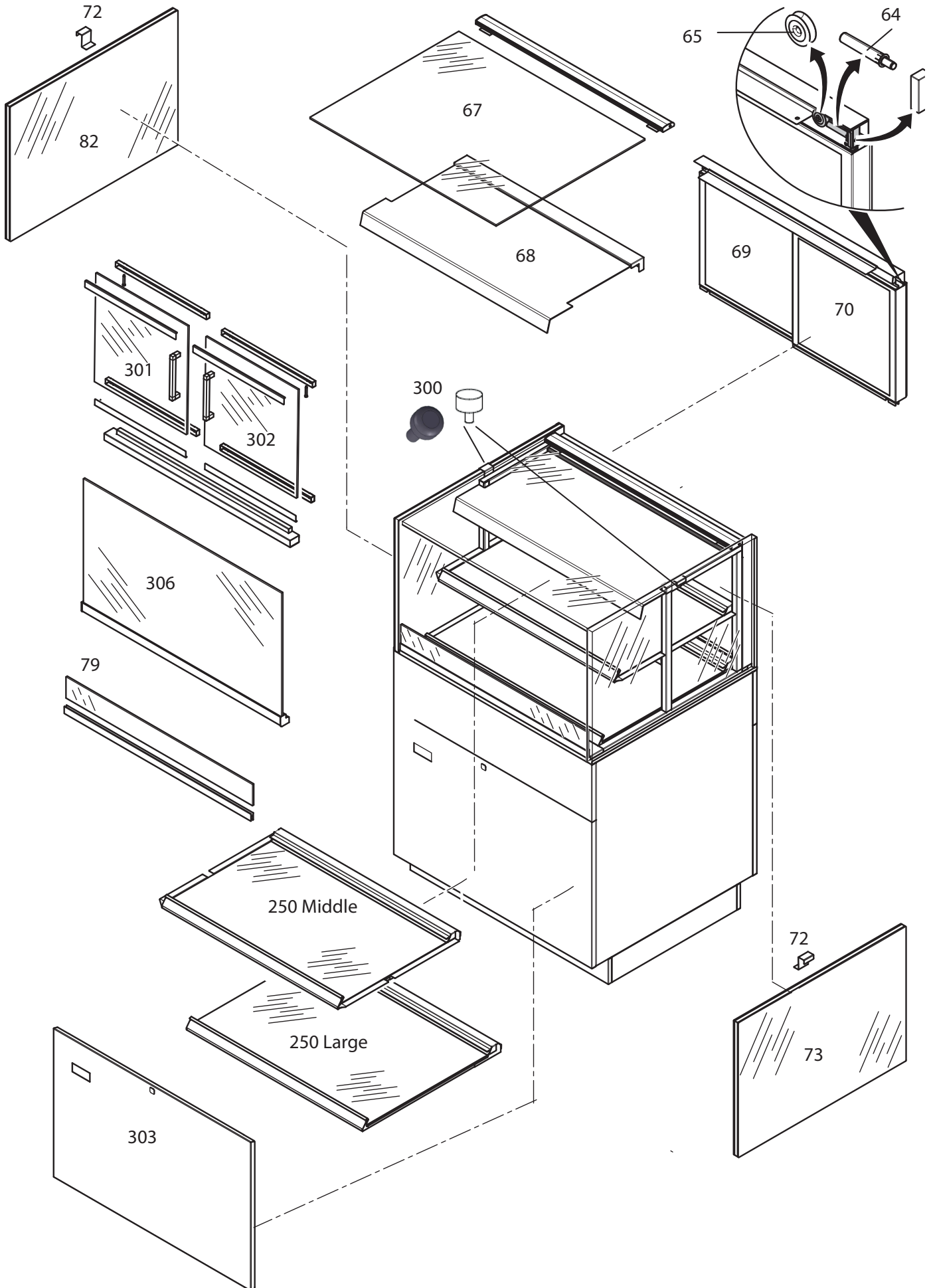

14.1 Exploded view MCC Hot 2 Level

Number	Description	Article number	Quantity
64	Soft close damper 3N	9281078	4
65	Steel roller bearing	9382100	4
67	Top Glass Square MCC 24 SS Top Glass Square MCC 36 SS Top Glass Square MCC 48 SS	9382165s 9382164s 9382166s	1 1 1
68	Air guide MCC 24 Air guide MCC 36 Air guide MCC 48	9382062 9382061 9382063	1 1 1
69	Assy Glass sliding door 24 Right Assy Glass sliding door 36 Right Assy Glass sliding door 48 Right	9380764 9380766 9380768	1 1 1
70	Assy Glass sliding door 24 Left Assy Glass sliding door 36 Left Assy Glass sliding door 48 Left	9380765 9380767 9380769	1 1 1
72	Side glass topside bracket	9384201	2
73	Side glass MCC 2 level	9382750s	2
76	Tool-clamp	8071090	4
77	Adjustable leg	9291162	4
79	Child guard assy MCC 24 Child guard assy MCC 36 Child guard assy MCC 48	9380017s 9380018s 9380019s	1 1 1
82	Side glass MCC 2 level	9382750s	2
250	Assy shelf MCC Hot SS 24 middle 230V Glass pane Assy shelf MCC Hot SS 24 large 230V Glass pane Assy shelf MCC Hot SS 36 middle 230V Glass pane Assy shelf MCC Hot SS 36 Large 230V Glass pane Assy shelf MCC Hot SS 48 middle 230V Glass pane Assy shelf MCC Hot SS 48 Large 230V Glass pane	9380350* 9382036 9380352* 9382037 9380346* 9382140 9380348* 9382142 9380344* 9382080 9380342* 9382081	*Complete packed shelf assy. including: glass, heating element and fan box, assembled
300	Plug top glass-pane (White) Plug top glass-pane (Black)	9263022 9381046	2 2
301	Assy. Front door Right MCC 90 2 level Assy. Front door Right MCC120 2 level Assy. Front door Right MCC150 2 level	9380585s 9380586s 9380587s seen from customer side	1 1 1
302	Assy. Front door Left MCC 24 2 level Assy. Front door Left MCC 36 2 level Assy. Front door Left MCC 48 2 level Assy. Front door Left MCC 60 2 level	9380581s 9380582s 9380583s 9380584s seen from customer side	1 1 1 1
	Set hinge screws for one door	30135910	1 per door
303	Front panel	On special request	1
306	Assy. glass pane till ted forward MCC 24 Assy. glass pane till ted forward MCC 36 Assy. glass pane till ted forward MCC 48	9382751s 9382752s 9382753s	1 1 1
801	Screw top hinge, Screws countersunk M4x6	0141335	3 per hinge

14.2 Exploded view MCC Hot 3 Level (Self Serve)

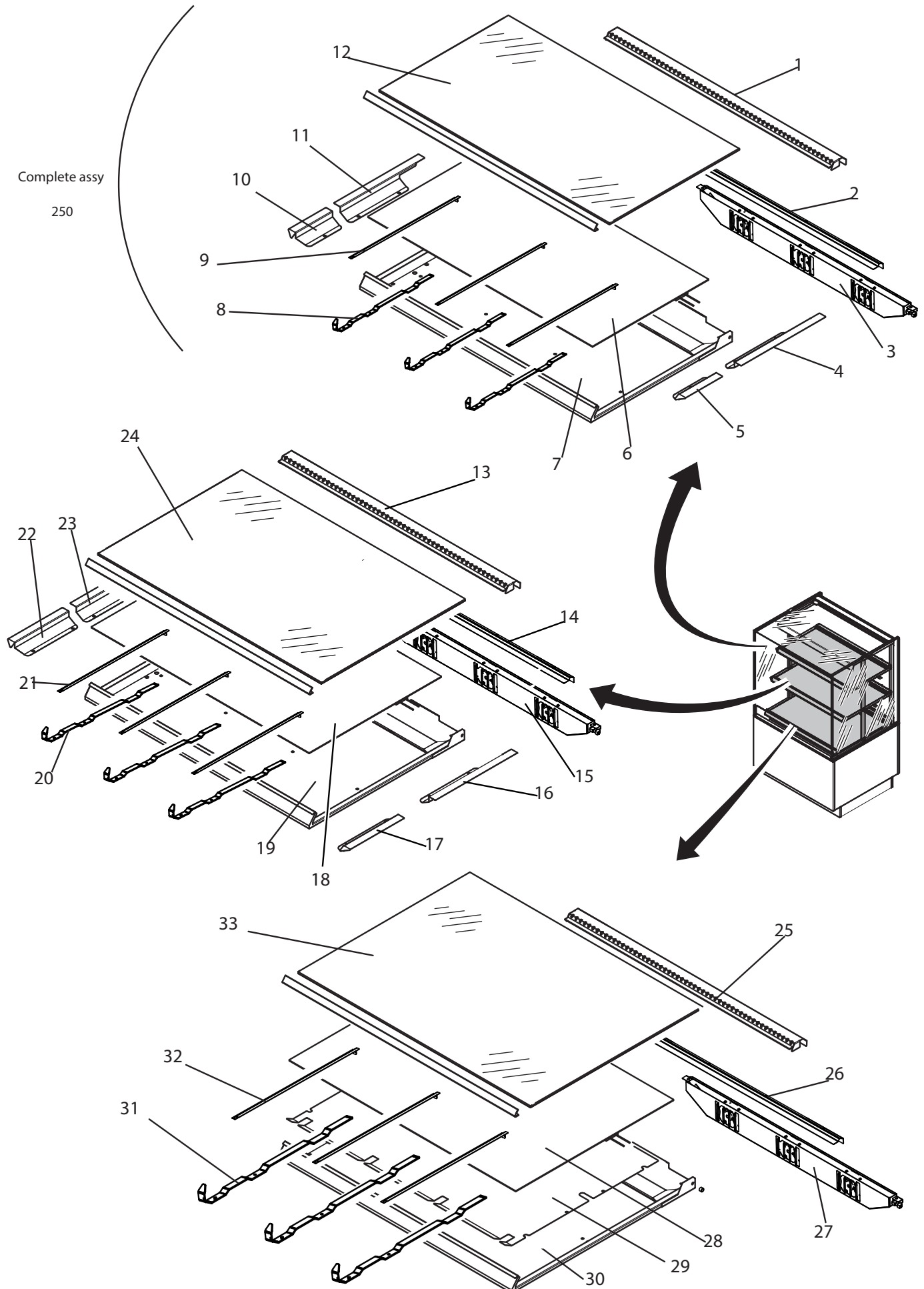

14.2 Exploded view MCC Hot 3 Level (Self Serve)

Number	Description	Article number	Quantity
1	Rear cover Shelf MCC 24	9384303	1
	Rear cover Shelf MCC 36	9384235	1
	Rear cover Shelf MCC 48	9384304	1
3	Fan Box Top MCC 24	9380072s	See Remark Serial number
	Fan Box Top MCC 36	9380058s	
	Fan Box Top MCC 48	9380074s	
4	Air blocker right rear top MCC 24	9384170	1
5	Air blocker right top MCC 24	9384069	1
6	Heating element 475x400 450W MCC 24	9382088	1
	Heating element 775x400 700W MCC 36	9382091	1
	Heating element 1075x400 1000W MCC 48	9382094	1
7	Weld. Assy Shelf MCC 24 Small	9380400	Complete shelf assy see 250
	Weld. Assy Shelf MCC 36 Small	9380403	
	Weld. Assy Shelf MCC 48 Small	9380406	
8	Support element Shelf Top	9384335	3
9	Element Clamp shelf top	9384334	3
10	Air blocker left top	9384068	1
11	Air blocker left rear top	9384169	1
12	Glass shelf Top MCC 24	9382035s	1
	Glass shelf Top MCC 36	9382141s	1
	Glass shelf Top MCC 48	9382079s	1
13	Rear cover Shelf MCC 24	9384303	1
	Rear cover Shelf MCC 36	9384235	1
	Rear cover Shelf MCC 48	9384304	1
15	Fan Box Middle MCC 24	9380072s	See remark serial number
	Fan Box Middle MCC 36	9380058s	
	Fan Box Middle MCC 48	9380074s	
16	Air blocker right rear top	9384170	1
17	Air blocker right middle	9384079	1
18	Heating element 475x470 550W MCC 24	9382089	1
	Heating element 775x470 850W MCC 36	9382092	1
	Heating element 1075x470 1150W MCC 48	9382095	1
19	Wled. Assy Shelf MCC 24 middle	9380401	1
	Wled. Assy Shelf MCC 36 middle	9380404	1
	Wled. Assy Shelf MCC 48 middle	9380407	1
20	Support element shelf middle	9384320	3
21	Element clamp shelf middle	9384321	3
22	Air blocker left middle	9384078	1
23	Air blocker left rear top	9384169	1
24	Glass shelf middle MCC 24	9382036s	1
	Glass shelf middle MCC 36	9382140s	1
	Glass shelf middle MCC 48	9382080s	1
25	Rear cover Shelf MCC 24	9384303	1
	Rear cover Shelf MCC 36	9384235	1
	Rear cover Shelf MCC 48	9384304	1
27	Fan Box Bottom MCC 24	9380072s	See remark serial number
	Fan Box Bottom MCC 36	9380058s	
	Fan Box Bottom MCC 48	9380074s	
28	Heating element 475x540 750W MCC 24	9382090	1
	Heating element 775x540 1125W MCC 36	9382093	1
	Heating element 1075x540 1500WMCC 48	9382096	1
29	Reflector plate MCC 24	9384086	1
	Reflector plate MCC 36	9384226	1
	Reflector plate MCC 48	9384184	1

14.3 Exploded view MCC Hot 3 Level (Self Serve)

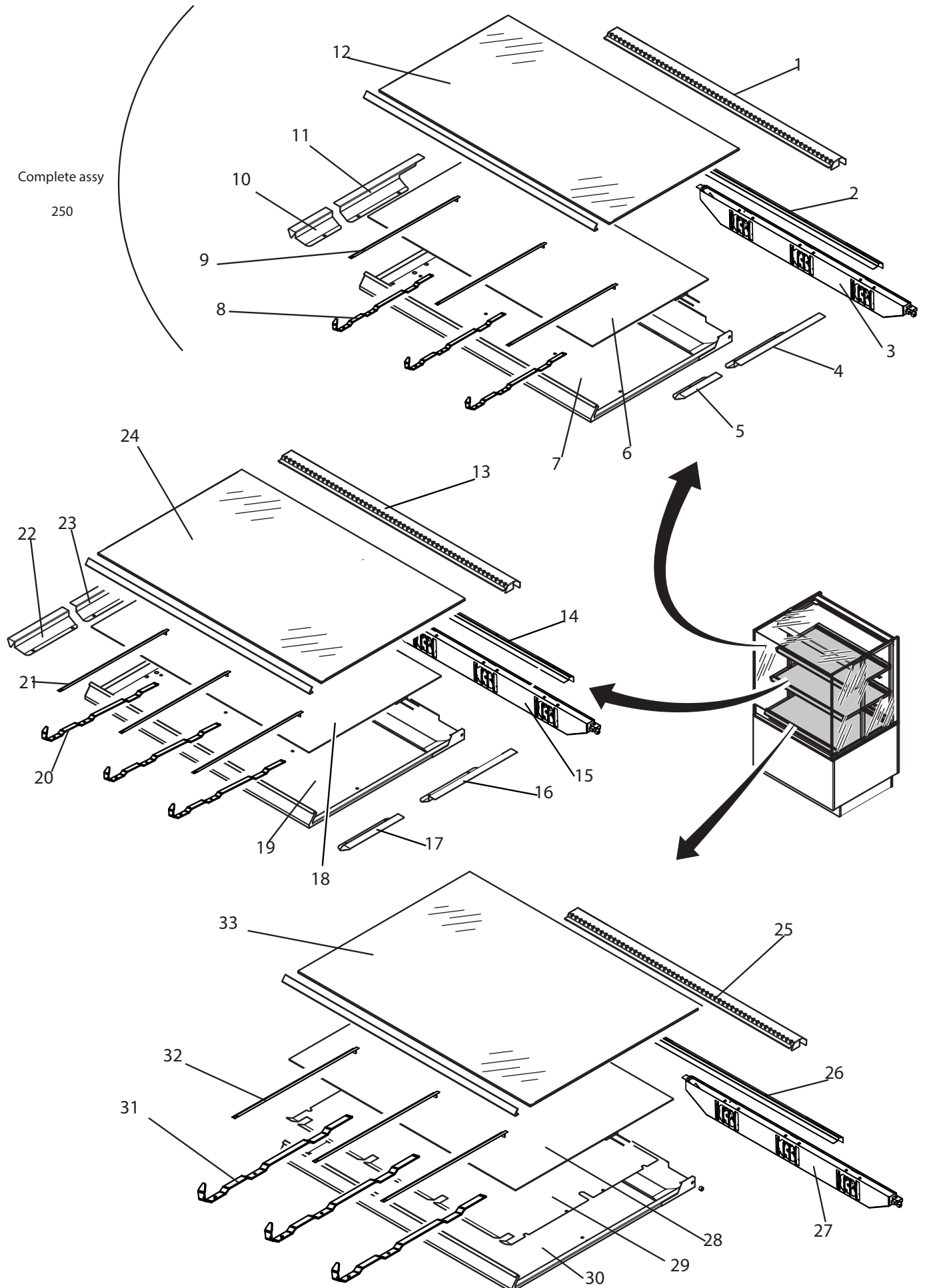

14.3 Exploded view MCC Hot 3 Level(Self Serve)

30	Assy Shelf MCC 24 bottom Assy Shelf MCC 36 bottom Assy Shelf MCC 48 bottom	9380402 9380405 9380408	1 1 1
31	Support element bottom shelf	9384337	1
32	Element clamp shelf bottom	9834336	1
33	Glass shelf bottom MCC 24 Glass shelf bottom MCC 36 Glass shelf bottom MCC 48	9382037s 9382142s 9382081s	Remark; Inner exhaust nozzle must be glued on
250	Assy shelf MCC Hot SS 24 small 230V Assy shelf MCC Hot SS 24 middle 230V Assy shelf MCC Hot SS 24 large 230V Assy shelf MCC Hot SS 36 small 230V Assy shelf MCC Hot SS 36 middle 230V Assy shelf MCC Hot SS 36 Large 230V Assy shelf MCC Hot SS 48 small 230V Assy shelf MCC Hot SS 48 middle 230V Assy shelf MCC Hot SS 48 Large 230V	9380081s 9380082s 9380085s 9380087s 9380089s 9380091s 9380093s 9380095s 9380097s	Complete packed shelf assy. including: glass, heating element and fan box, assembled

14.4 Exploded view MCC Hot 3 Level (Self Serve)

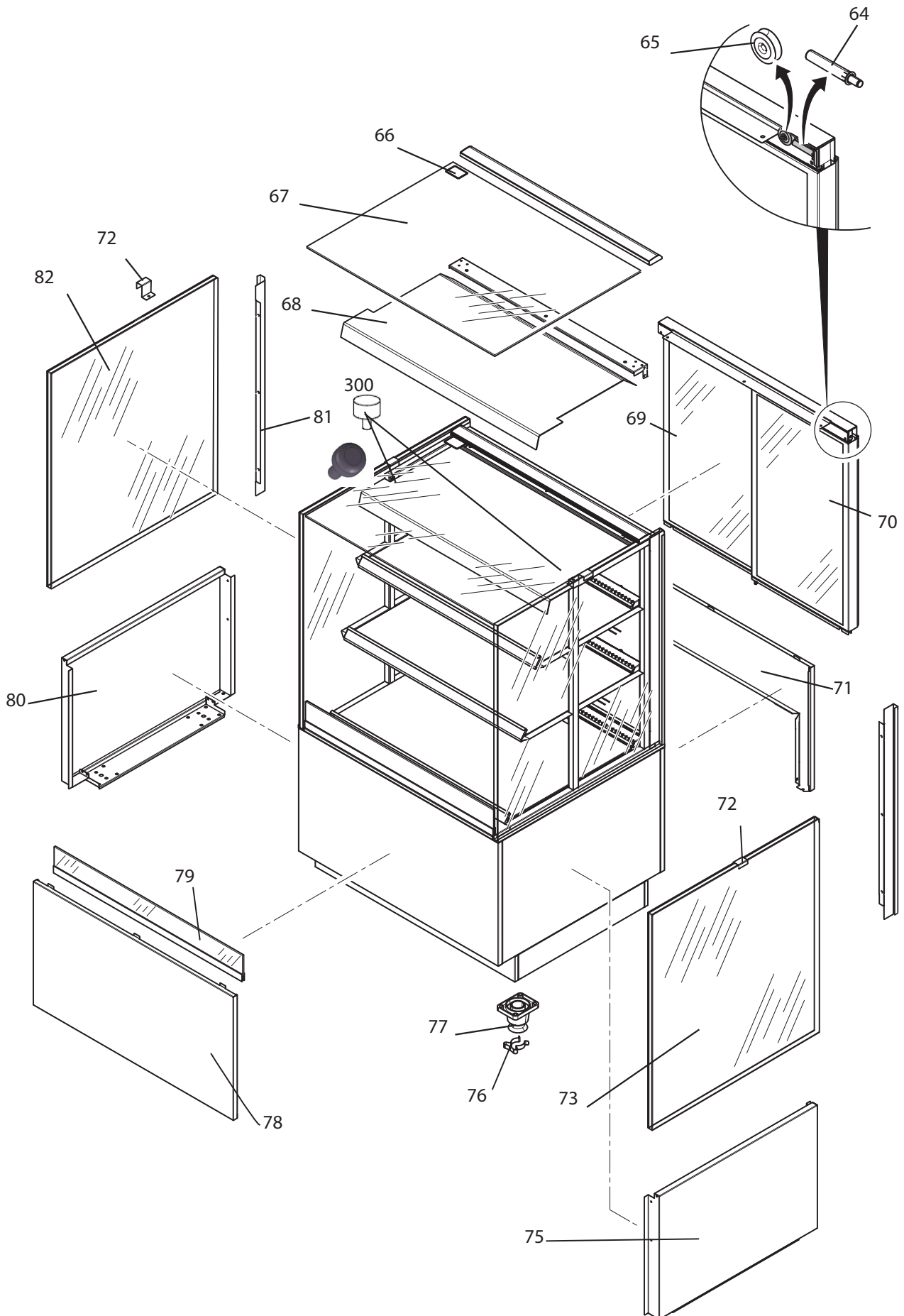

14.4 Exploded view MCC Hot 3 Level (Self Serve)

Number	Description	Article number	Quantity
64	Soft close damper 3N	9281078	4
65	Steel roller bearing	9382100	4
66	Label max. Load 10 kg	9123759	1
67	Top Glass Square MCC 24 SS Top Glass Square MCC 36 SS Top Glass Square MCC 48 SS	9382165s 9382164s 9382166s	1 1 1
68	Air guide MCC 24 Air guide MCC 36 Air guide MCC 48	9382062 9382061 9382063	1 1 1
69	Assy Glass sliding door 24 Right V0 Assy Glass sliding door 24 Right V1 Assy Glass sliding door 36 Right V0 Assy Glass sliding door 36 Right V1 Assy Glass sliding door 48 Right V0 Assy Glass sliding door 48 Right V1	9380226s 9380216s 9380220s 9380210s 9380222s 9380212s	1 1 1 1 1 1
70	Assy Glass sliding door 24 Left Assy Glass sliding door 36 Left Assy Glass sliding door 48 Left	9380217s 9380211s 9380213s	1 1 1
71	Back panel MCC 24 Back panel MCC 36 Back panel MCC 48	9384006 9384007 9384008	1 1 1
72	Side glass topside bracket	9384201	1
73	Side glass MCC 3 + 4 level	9382030s	2 (see 82)
74	Base end cover panel	9384021	
75	Side panel MCC 3 + 4 Level	9384005	2 (see 80)
76	Tool-clamp	8071090	1
77	Adjustable leg	9291162	4
78	Front panel MCC 48 Front panel MCC 36 Front panel MCC 48	9384001 9384002 9384003	1 1 1
79	Child guard assy MCC 24 Child guard assy MCC 36 Child guard assy MCC 48	9380017s 9380018s 9380019s	1 1 1
80	Side panel MCC 3 + 4 Level	9384005	2 (see 75)
81	Base end cover panel MCC 3 + 4 Left Base end cover panel MCC 3 + 4 Right	9384048 9384042	1 1
82	Side glass MCC 3 + 4 level	9382030s	2 (see 73)
300	Plug top glass-pane (White) Plug top glass-pane (Black)	9263022 9381046	2 2
801	Screw top hinge, Screws countersunk M4x6	0141335	3 per hinge

14.5 Exploded view MCC Hot Structure X level (Full Serve version 1)

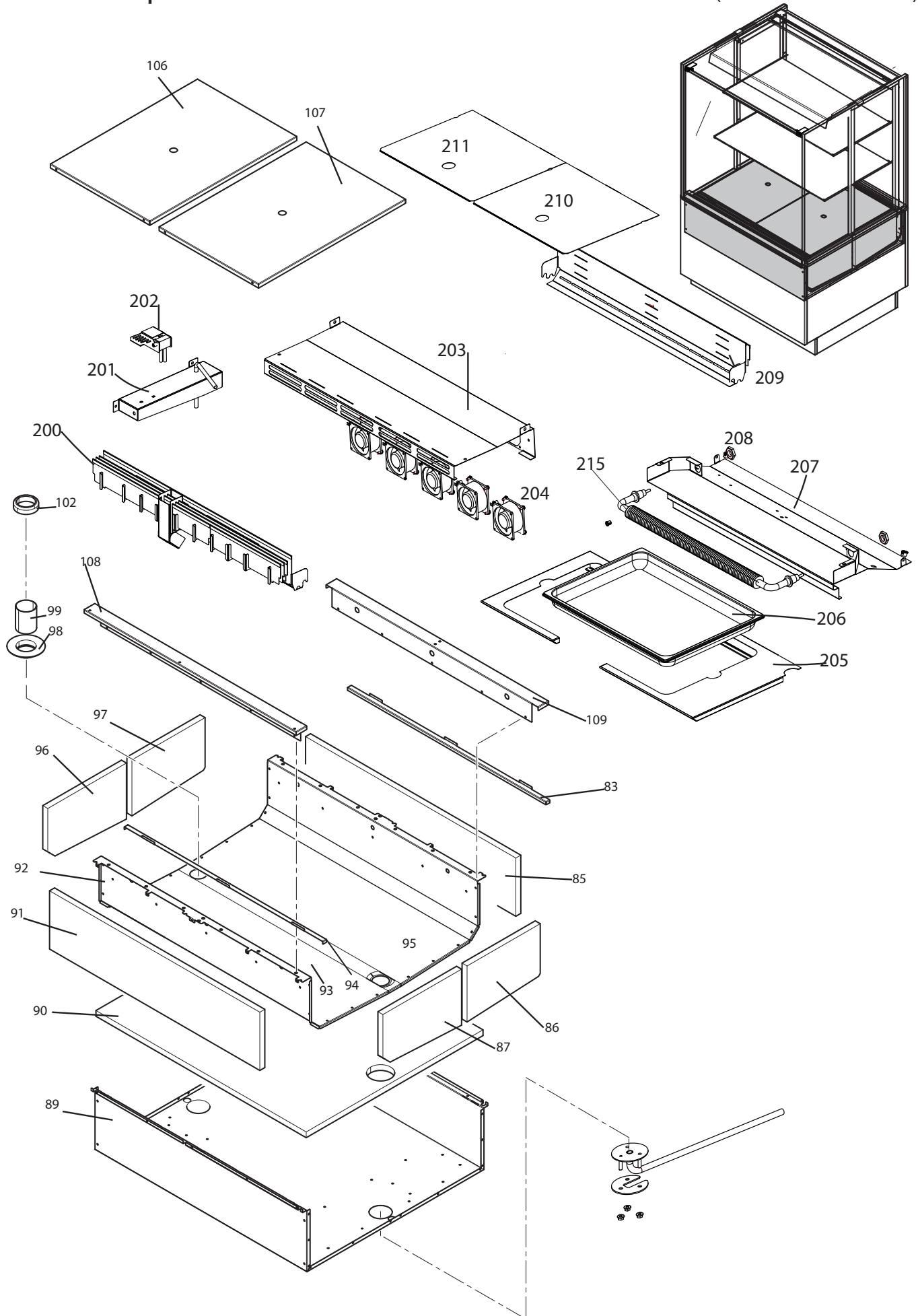

14.5 Exploded view MCC Hot Structure X level (Full Serve version 1)

Number	Description	Article number	Quantity
83 / 94	product plateau support MCC 24 product plateau support MCC 36 product plateau support MCC 48	9384122 9384082 9384125	2 2 2
85	Insulation back MCC 24 Insulation back MCC 36 Insulation back MCC 48	9382177 9382172 9382173	1 1 1
86 / 87 / 96 / 97	Insulation side cold set of two	9382078	set of 2
89	Base outer frame MCC 24 Base outer frame MCC 36 Base outer frame MCC 48	9384023 9384024 9384025	1 1 1
90	Insulation bottom MCC 24 Insulation bottom MCC 36 Insulation bottom MCC 48	9382076 9382083 9382119	1 1 1
91	Insulation front	9382077	1
92	Inner shell MCC 24 Inner shell MCC 36 Inner shell MCC 48	9384096 9384142 9384219	1 1 1
102	Rosette type 240 1 1/4"	9381001	1
106 / 107	Product plateau 98,5 inch Product plateau 157,5 inch Product plateau 169,8 inch Product plateau 216,5 inch Product plateau 98,5 inch Black Product plateau 157,5 inch Black Product plateau 169,8 inch Black Product plateau 216,5 inch Black	9385000 9384081 9384137 9384138 9384999 9384348 9384554 9384555	2 2 2 2 2 2 2 2
202	Water level sensor	9382215s	1
203		Only on special request	
204	Fan 8556N	30010380s	4 till 7
205		Only on special request	
206	GN pan MCC 24 GN pan MCC 36 GN pan MCC 48	Only on special request	1 1 1
208	Nut connection heating element		1
209		Only on special request	
210 / 211	Deck		2
215 (230 Volts)	Element MCC 24 1500W 230V Element MCC 36 1800W 230V Element MCC 48 2400W 230V	9382269s 30002245s 30002244s	1 1 1

14.6 Exploded view MCC Hot Structure X level (Full Serve version 2)

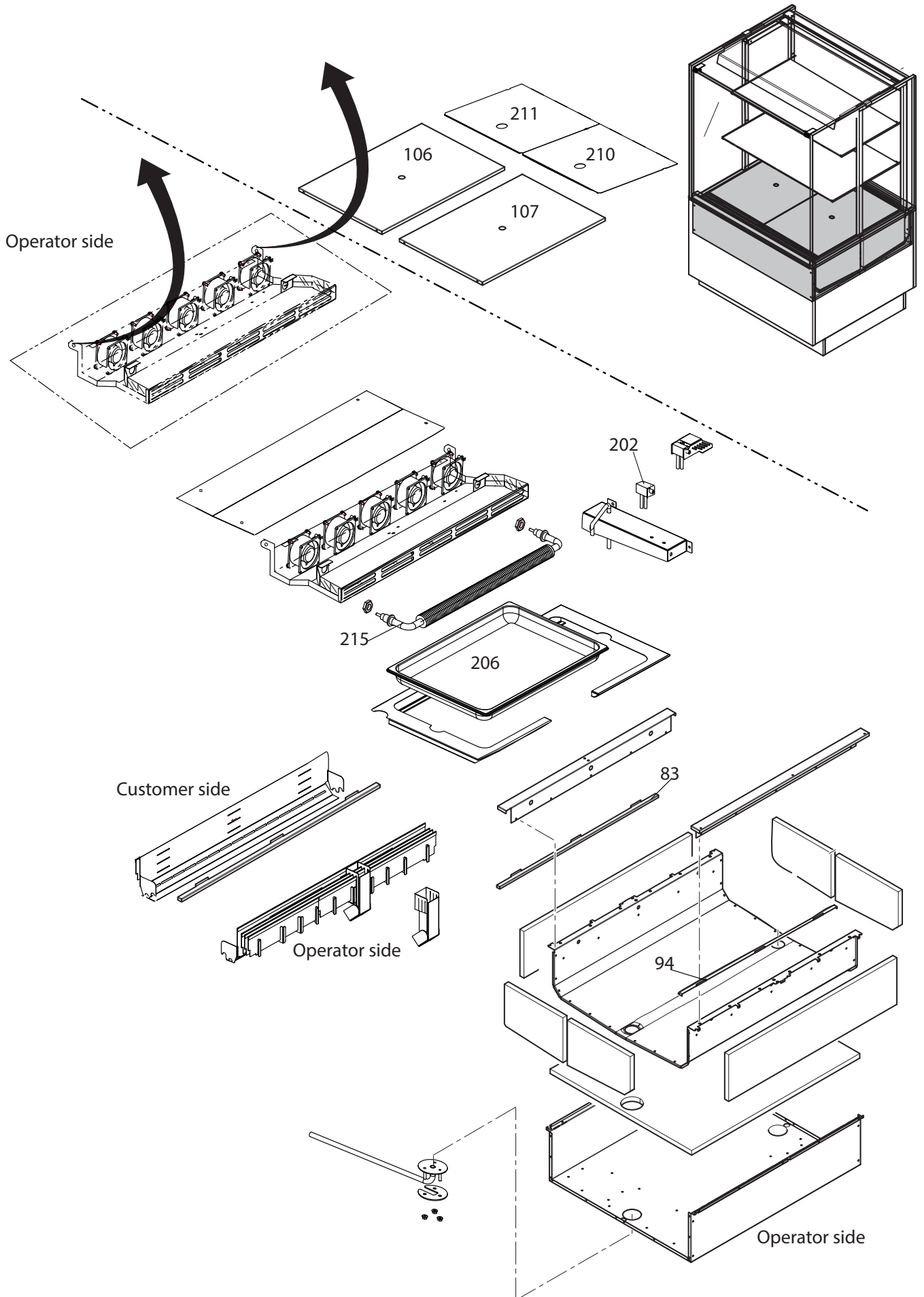

14.6 Exploded view MCC Hot Structure X level

(Full Serve version 2)

Number	Description	Article number	Quantity
83 / 94	product plateau support MCC 24 product plateau support MCC 36 product plateau support MCC 48	9384122 9384082 9384125	2 2 2
106 / 107	Product plateau 98,5 inch Product plateau 157,5 inch Product plateau 169,8 inch Product plateau 216,5 inch Product plateau 98,5 inch Black Product plateau 157,5 inch Black Product plateau 169,8 inch Black Product plateau 216,5 inch Black	9385000 9384081 9384137 9384138 9384999 9384348 9384554 9384555	2 2 2 2 2 2 2 2
202	Water level sensor	9382215s	1
204	Fan 8556N	30010380s	4 till 7
206	GN pan MCC 24 GN pan MCC 36 PN pan MCC 48		1 1 1
210 / 211	Deck	Only on special request	2
215 (230 Volts)	Element MCC 24 1500W 230V Element MCC 36 1800W 230V Element MCC 48 2400W 230V	9382269s 30002245s 30002244s	1 1 1
215 (208 Volts)	Element MCC 24 1500W 208V Element MCC 36 1800W 208V Element MCC 48 2400W 208V	9382270s 9382176 9382177	1 1 1

14.7 Exploded view MCC Hot 4 Level

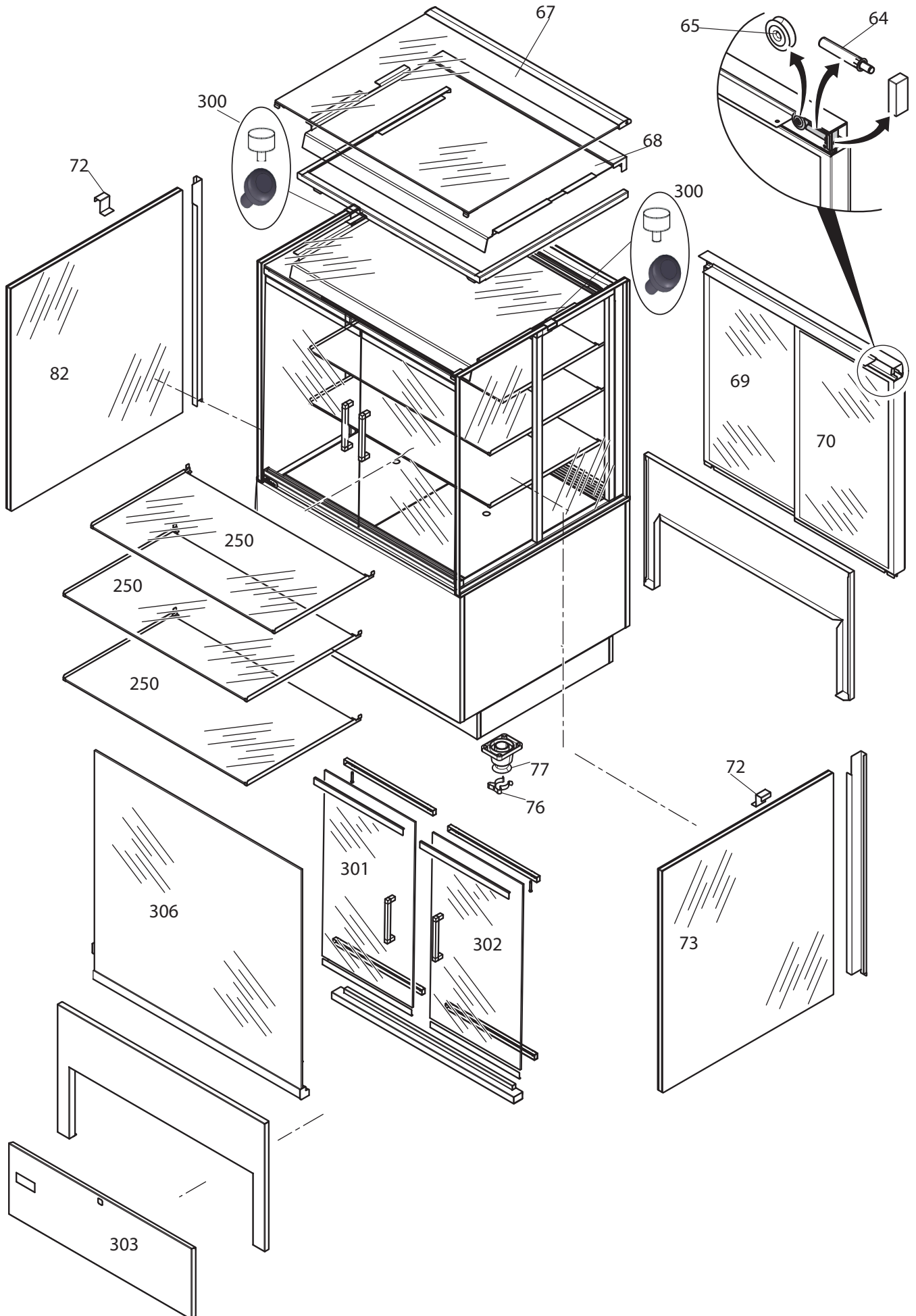

14.7 Exploded view MCC Hot 4 Level

Number	Description	Article number	Quantity
64	Soft close damper 3N	9281078	4
65	Steel roller bearing	9382100	4
67	Top Glass Square MCC 24 Top Glass Square MCC 36 Top Glass Square MCC 48	9380203s 9380200s 9380201s	1 1 1
68	Air guide MCC 24 Air guide MCC 36 Air guide MCC 48	9382062 9382061 9382063	1 1 1
69	Assy Glass sliding door 24 Right Assy Glass sliding door 36 Right Assy Glass sliding door 48 Right	9380216s 9380210s 9380212s	1 1 1
70	Assy Glass sliding door 24 Left Assy Glass sliding door 36 Left Assy Glass sliding door 48 Left	9380217s 9380211s 9380213s	1 1 1
72	Side glass topside bracket	9384201	2
73	Side glass MCC	9382030s	2 (see 82)
76	Toolclamp	8071090	4
77	Adjustable leg	9291162	4
82	Side glass MCC	9382030s	2 (see 73)
85	Front glass pane tilted forward MCC 24 Front glass pane tilted forward MCC 36 Front glass pane tilted forward MCC 48 Front glass pane tilted forward MCC 60	9382033s 9382029s 9382034s 9382123s	1 1 1 1
250	Glass plateau MCC 24 167 inch Glass plateau MCC 24 193 inch Glass plateau MCC 36 167 inch Glass plateau MCC 36 193 inch Glass plateau MCC 48 167 inch Glass plateau MCC 48 193 inch	9380423 9380424 9380425 9380426 9380427 9380428	1 1 1 1 1 1
300	Plug top glass-pane (White) Plug top glass-pane (Black)	9263022 9381046	2 2
301	Assy. front door left MCC 24 3/4 level Assy. front door left MCC 36 3/4 level Assy. front door left MCC 48 3/4 level Assy. front door left MCC 60 3/4 level	9380381s 9380382s 9380383s 9380384s	1 1 1 1
302	Assy. front door right MCC 36 3/4 level Assy. front door right MCC 48 3/4 level Assy. front door right MCC 60 3/4 level	9380385s 9380386s 9380387s	1 1 1
303	Front panel turnable MCC 24 Front panel turnable MCC 36 Front panel turnable MCC 48	On request	1 1 1
	Set hinge screws for one door 	30135910	1 per door
306	Assy. glass tiled forward MCC 24 Assy. glass tiled forward MCC 36 Assy. glass tiled forward MCC 48	9382033s 9382029s 9382034s	1 1 1
801	Screw top hinge, Screws countersunk M4x6	0141335	3 per hinge

14.8 Exploded view MCC Hot Electrical

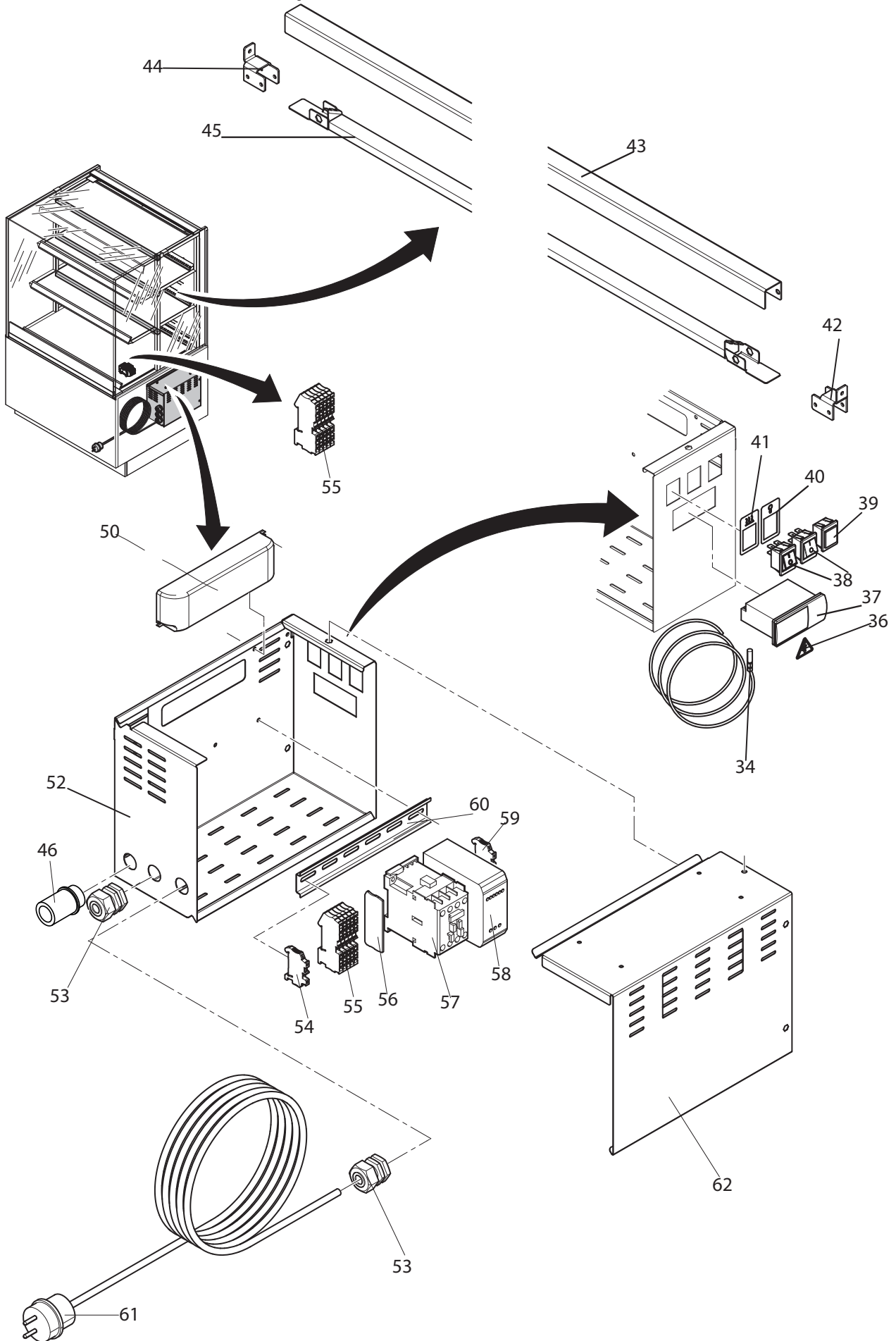

14.8 Exploded view MCC Hot Electrical

Number	Description	Article number	Quantity
34	Sensor PTC 1000	9221011	1
35	Model plate	9110810	1
36	Sticker Black Elect. Sign triangle	3500105	1
37	Thermostat ERC211	9221109	1
38	Switch	9181008	2
39	Switch dummy	30002730	Depending variation
40	Sticker Lighting	9181071	1
41	Sticker Lower Heat	9181072	1
42	Led Armature support bracket	9384091	Depending variation
43	LED Armature MCC 24 LED Armature MCC 36 LED Armature MCC 48	9384110 9384090 9384111	Depending variation
45	Led 3000k 12V 158 inch MCC 24 Led 3000k 12V 275 inch MCC 36 Led 3000k 12V 394 inch MCC 48	9382075s 9382067s 9382068s	Depending variation
44	Led Armature support bracket	9384091	Depending variation
50	Led driver EDXe 160/12.054	30007730	1
52	Box electronics	9384094	1
53	Strain relief Nut for cable gland	9222076 9222077	1 1
54	End Clamp Clip-fix 35-5 PHX	9191222	1
55	Terminal PT 4 (GN/YE) Terminal PT 4 (GY)	9191239 9191240	Depending variation
56	End cover D=PT 4 PHX	9191223	2
57	Contacto AB100-C09KL400	3500069	1
58	Power supply 24VDC 40W	9381012	See remark serial number
59	End Clamp Clip-fix 35-5 PHX	9191222	2
60	Din rail	9293057	1
61	Power cable	9091383	1
62	Cover Electronics box	9384095	1

14.9 Exploded view MCC Hot Electrical (Humidified)

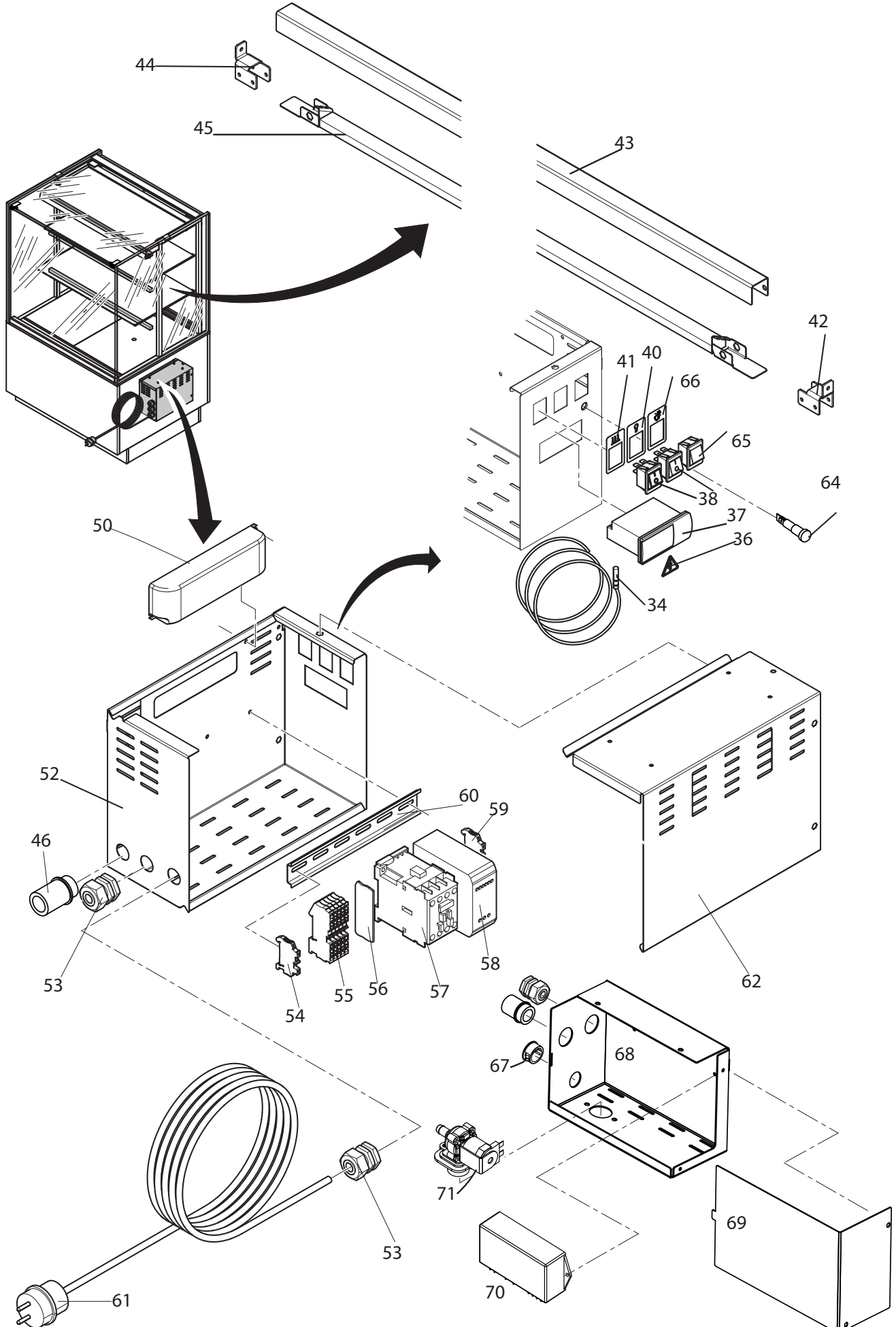

14.9 Exploded view MCC Hot Electrical (Humidified)

Number	Description	Article number	Quantity
34	Sensor PTC 1000	9221011	1
35	Model plate	9110810	1
36	Sticker Black Elect. sign triangle	3500105	1
37	Thermostat ERC211	9221109	1
38	Switch	9181008	2
39	Switch dummy	30002730	Depending variation
40	Sticker Lightning	9181071	Depending variation
41	Sticker Lower Heat	9181072	1
42	Led Armature support bracket	9384091	Depending variation
43	LED Armature MCC 24 LED Armature MCC 36 LED Armature MCC 48	9384110 9384090 9384111	Depending variation
45	Led 3000k 12V 158 inch MCC 24 Led 3000k 12V 275 inch MCC 36 Led 3000k 12V 394 inch MCC 48	9382075 9382067 9382068	Depending variation
44	Led Armature support bracket	9384091	Depending variation
50	Led driver EDXe 160/12.054	30007730	1
52	Box electronics	9384094	1
53	Strain relief Nut for cable gland	9222076 9222077	Depending variation
54	End Clamp Clipfix 35-5 PHX	9191222	Depending variation
55	Terminal PT 4 (GN/YE) Terminal PT 4 (GY)	9191239 9191240	Depending variation
56	End cover D=PT 4 PHX	9191223	2
57	Contactactor AB100-C09KL400	3500069	1
58	Power supply 24VDC 40W	9381012	See remark serial number
59	End Clamp Clipfix 35-5 PHX	9191222	2
60	Dinn rail	9293057	1
61	power cable	9091383	1
62	Cover Electronics box	9384095	1
64	signal light	9291031	1
65	reset switch	9381042	1
66	label reset switch	30004729	1
70	PCB water level control	9181047s	1
71	Valve inlet 2.5l.min	9261040s	1

15.0 Electrical schematic MCC Hot (Self Serve, One phase)



Schematics till production week 42 2021

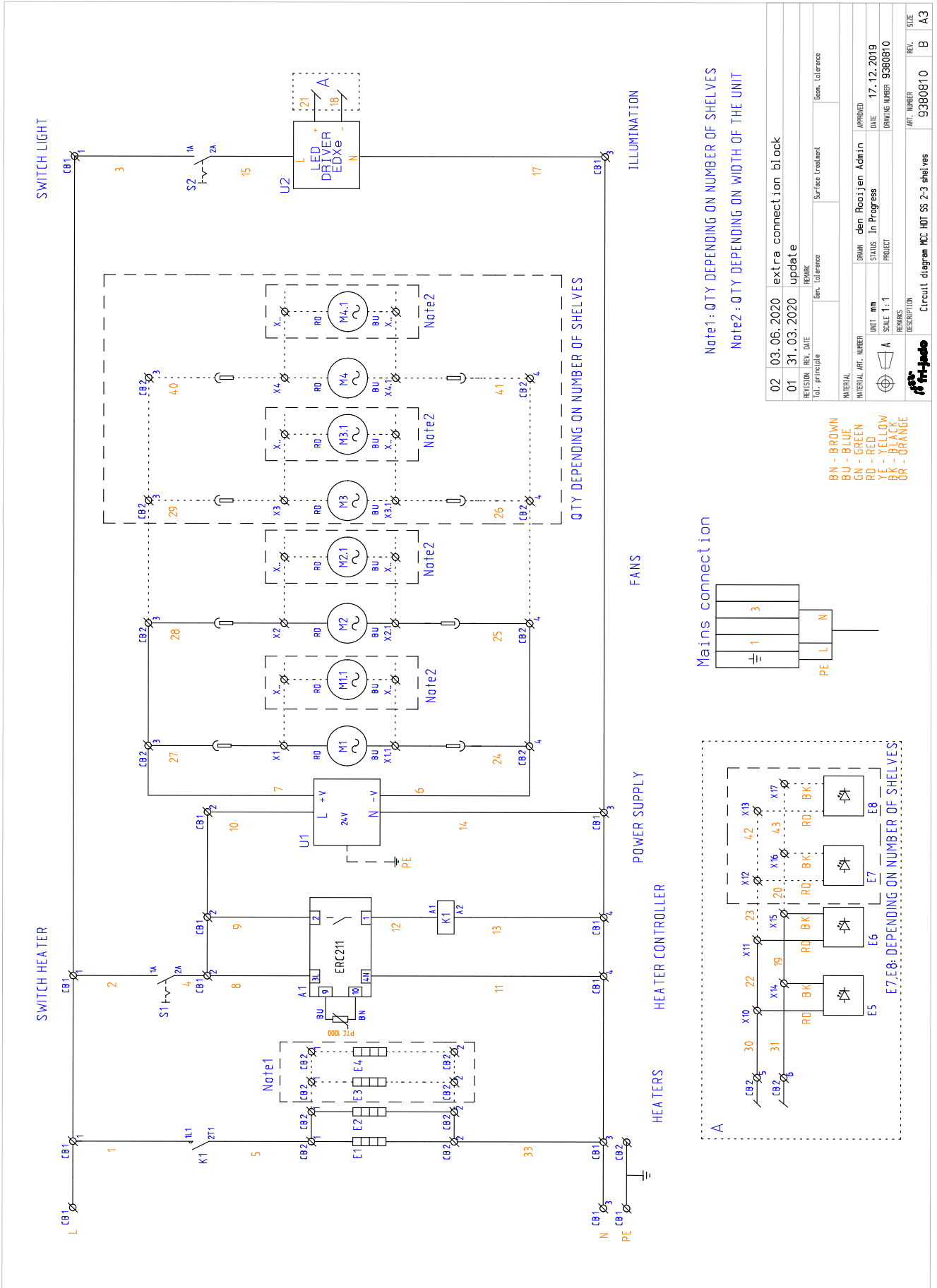

Note1: QTY DEPENDING ON NUMBER OF SHELVES
 Note2: QTY DEPENDING ON WIDTH OF THE UNIT

Mains connection

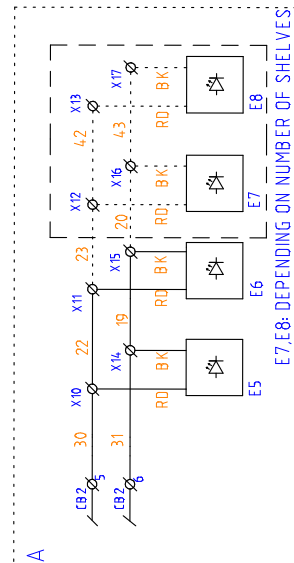
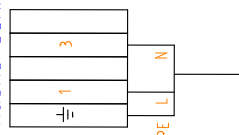

- BN - BROWN
- BU - BLUE
- GN - GREEN
- RD - RED
- YE - YELLOW
- BK - BLACK
- OR - ORANGE

REVISION	REV. DATE	REMARK	Gen. Tolerance	Surface Treatment	Gen. Tolerance
02	03.06.2020	extra connection block update			
01	31.03.2020				
MATERIAL		DRWN	den Rooijen	Admin	APPROVED
MATERIAL ART. NUMBER		UNIT	mm	STATUS	In Progress
		SCALE	1:1	PROJECT	17.12.2019
		REMARKS		DRAWING NUMBER	9380810
		DESCRIPTION		ART. NUMBER	REL. SIZE
		Circuit diagram MCC HOT SS 2-3 shelves		9380810	B A3

15.0.1 Electrical wiring MCC Hot (Self Serve, One phase)

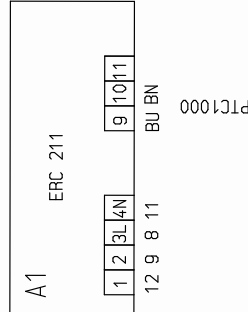
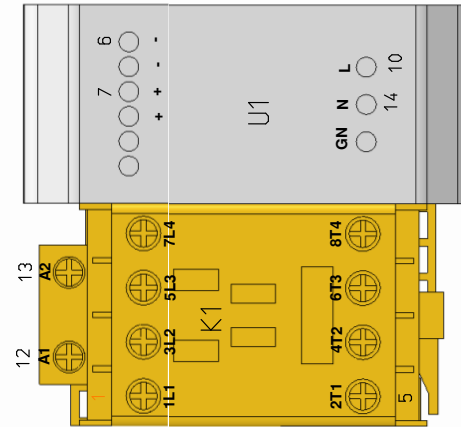
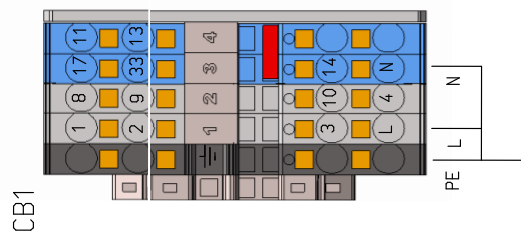
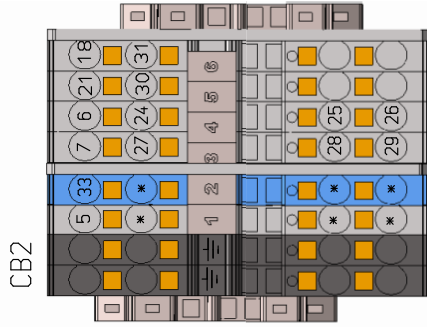
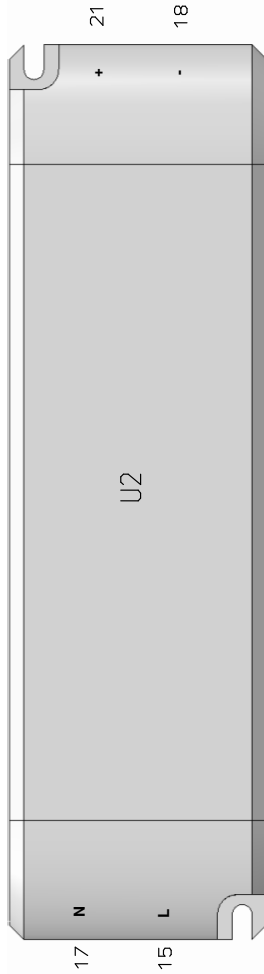

* : connection for elements (qty depending on unit)
WIPE 26, 29 only used with 3 shelves

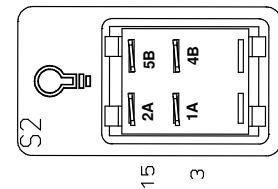
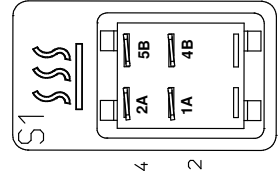

power supply

03	17.08.2020	blue blocks	DRAWN	den Rocqjen Admin	APPROVED
02	03.06.2020	extra connection block	STATUS	In Progress	DATE
REVISION / REV. DATE		REMARK	DRAWING NUMBER 9380811		
for: Principe		Gen. tolerance	Surface treatment		
MATERIAL		UNIT mm			
MATERIAL ART. NUMBER		SCALE 1:2		PROJECT	
REVISION		REMARKS		DESCRIPTION	
A		A		Wiring diagram HOT SS 2-3 shelves	
ART. NUMBER		REV.		SIZE	
9380811		C		A3	

15.0.2 Electrical schematic MCC Hot (Self Serve)



Schematics started production week 42 2021

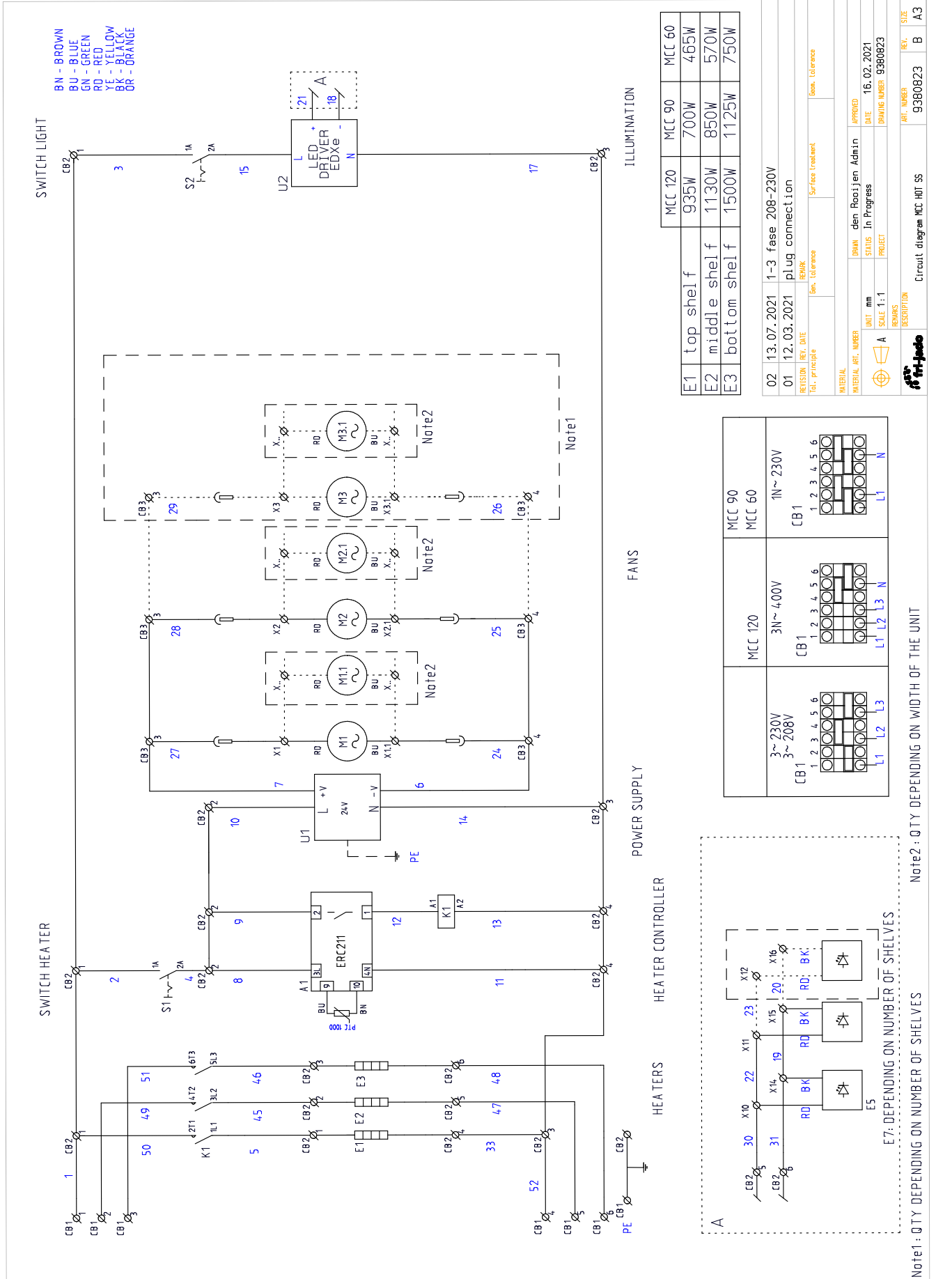

E1	top shelf	MCC 120	MCC 90	MCC 60
E2	middle shelf	935W	700W	465W
E3	bottom shelf	1130W	850W	570W
		1500W	1125W	750W

02	13.07.2021	1-3 fase 208-230V		
01	12.03.2021	plug connection		
REVISION		REV. DATE	REMARK	APPROVED
Tol., tolerance		Ben., tolerance	Surface treatment	Ben., tolerance
MATERIAL		DWHN den Rooijen Admin		
MATERIAL ART. NUMBER		UNIT: mm	STATUS: In Progress	DATE: 16.02.2021
SCALE 1:1		DRAWING NUMBER: 9380823		
DESCRIPTION		Circuit diagram MCC HOT SS		
ART. NUMBER	REV.	SIZE		
9380823	B	A3		

15.0.3 Electrical wiring MCC Hot (Self Serve)

Schematics started production week 42 2021

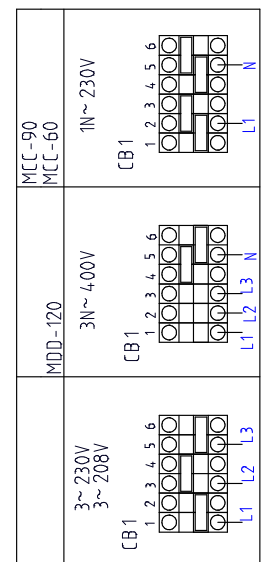
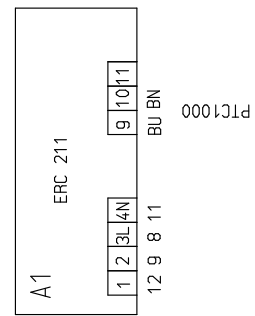
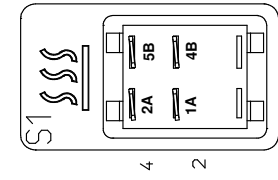
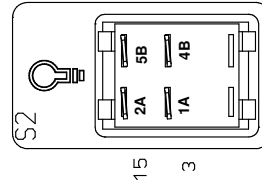
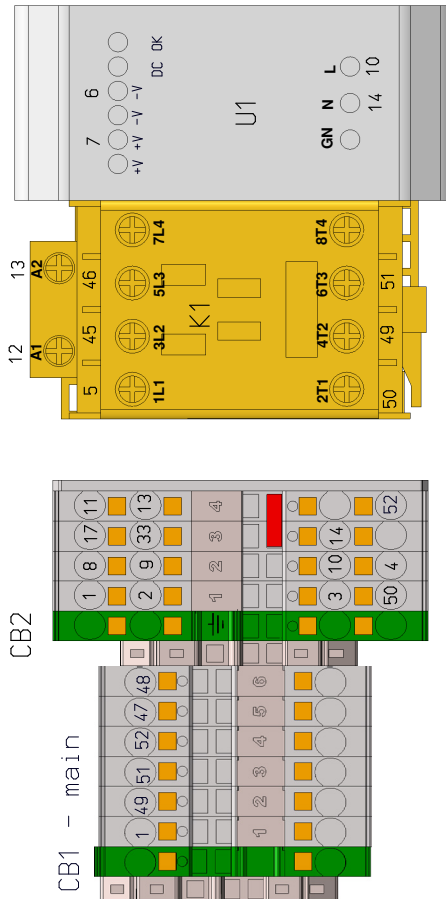
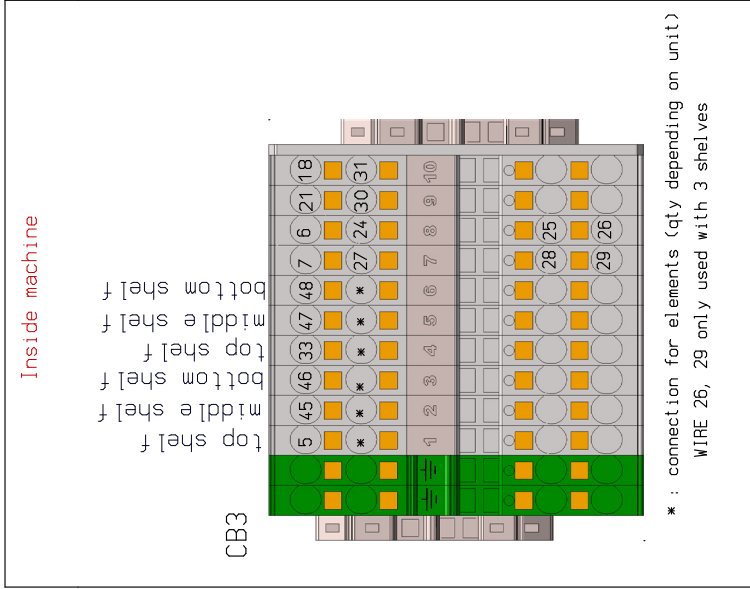
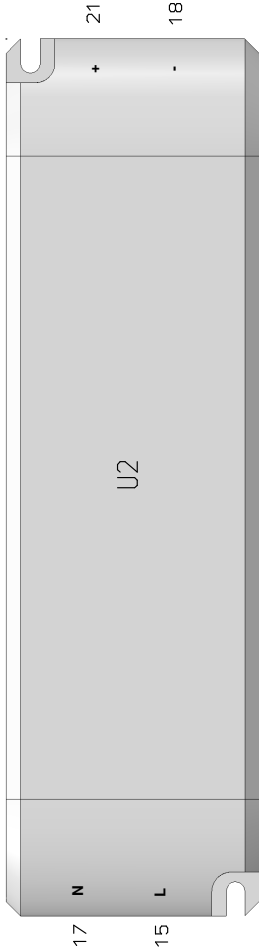

03	09.07.2021	1-3fase 230v 208v in een schema			
02	27.05.2021	connections U1			
REVISION		REV. DATE	REV. DATE	REV. DATE	REV. DATE
Tol., principle		Ben. Tolerance	Surface treatment	Ben. Tolerance	
MATERIAL		ART. NUMBER	DRAWN	den Rooijen Admin	APPROVED
UNIT		mm	STATUS	In Progress	DATE
SCALE		1:2	PROJECT		DRAWING NUMBER
REMARKS					ART. NUMBER
DESCRIPTION		Wiring diagram HOT SS 2-3 shelves			REV. SIZE
					C A3

15.1.0 Electrical schematic MCC Hot (Self Serve) (One phase and time relay)

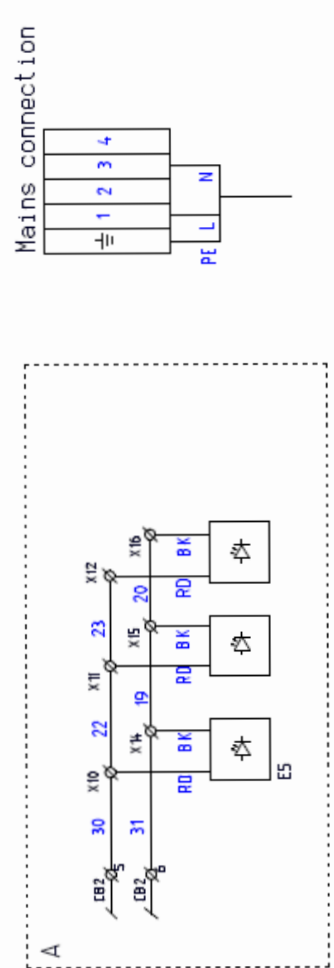
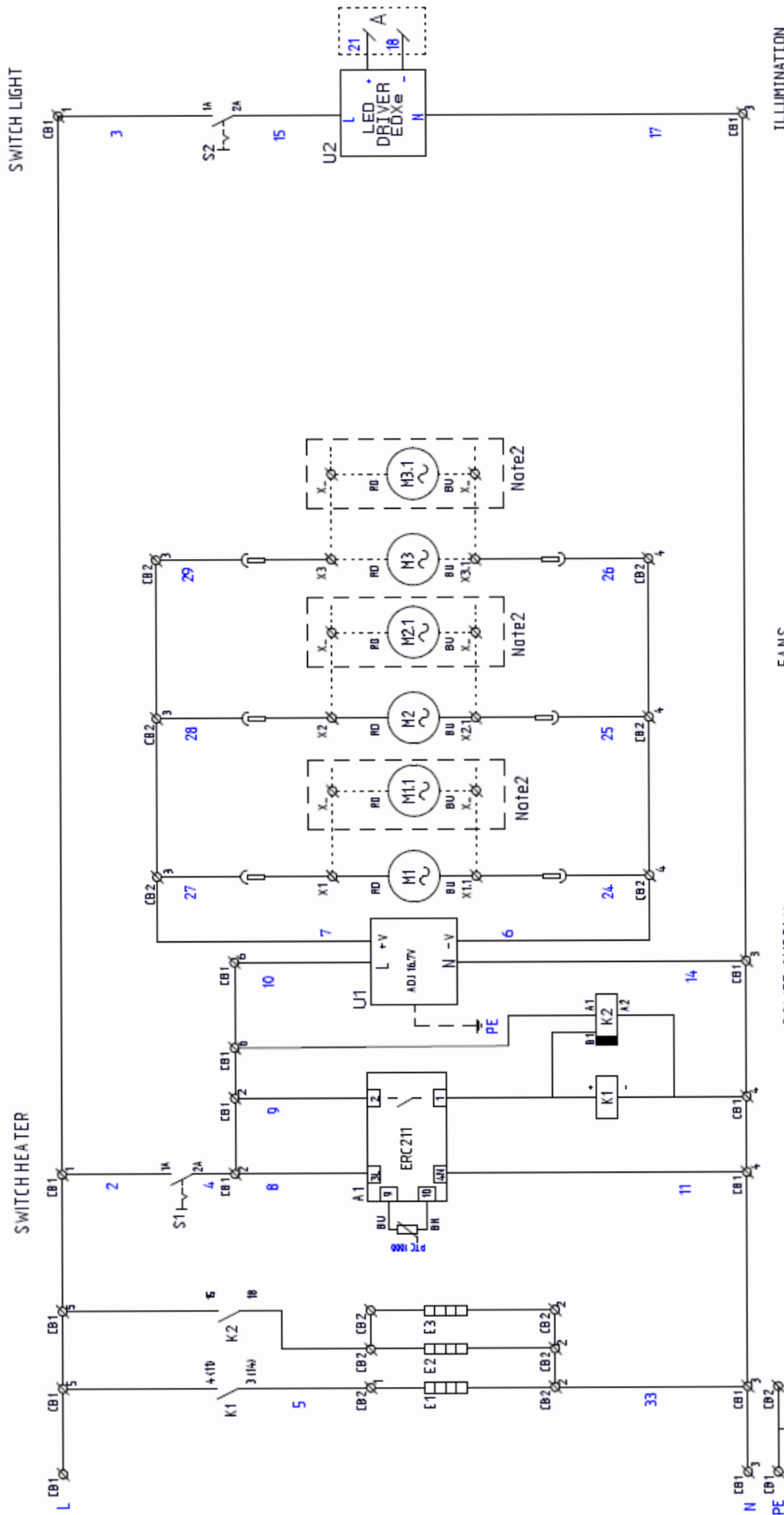

- BN - BROWN
- BU - BLUE
- GN - GREEN
- RD - RED
- YE - YELLOW
- BK - BLACK
- OR - ORANGE

Note2: QTY DEPENDING ON WIDTH OF THE UNIT

01	03.09.2020	update e	REVISI	REVISI	REVISI	REVISI	REVISI	REVISI	REVISI
REVISION	REV. DATE	REVISI	REVISI	REVISI	REVISI	REVISI	REVISI	REVISI	REVISI
Tu. principal	San. tekniska	San. tekniska	San. tekniska	San. tekniska	San. tekniska	San. tekniska	San. tekniska	San. tekniska	San. tekniska
INITIAL	REV. DATE	REVISI	REVISI	REVISI	REVISI	REVISI	REVISI	REVISI	REVISI
INITIAL	REV. DATE	REVISI	REVISI	REVISI	REVISI	REVISI	REVISI	REVISI	REVISI
UNIT	NO	UNIT	NO	UNIT	NO	UNIT	NO	UNIT	NO
SCALE	1:1	SCALE	1:1	SCALE	1:1	SCALE	1:1	SCALE	1:1
REMARKS		REMARKS		REMARKS		REMARKS		REMARKS	
DESCRIPTION		DESCRIPTION		DESCRIPTION		DESCRIPTION		DESCRIPTION	
Circuit diagram MCC HOT SS 90-3 Line-relaisedju									9380830
									A

15.1.1 Electrical wiring MCC Hot (Self Serve) (One phase and time relay)

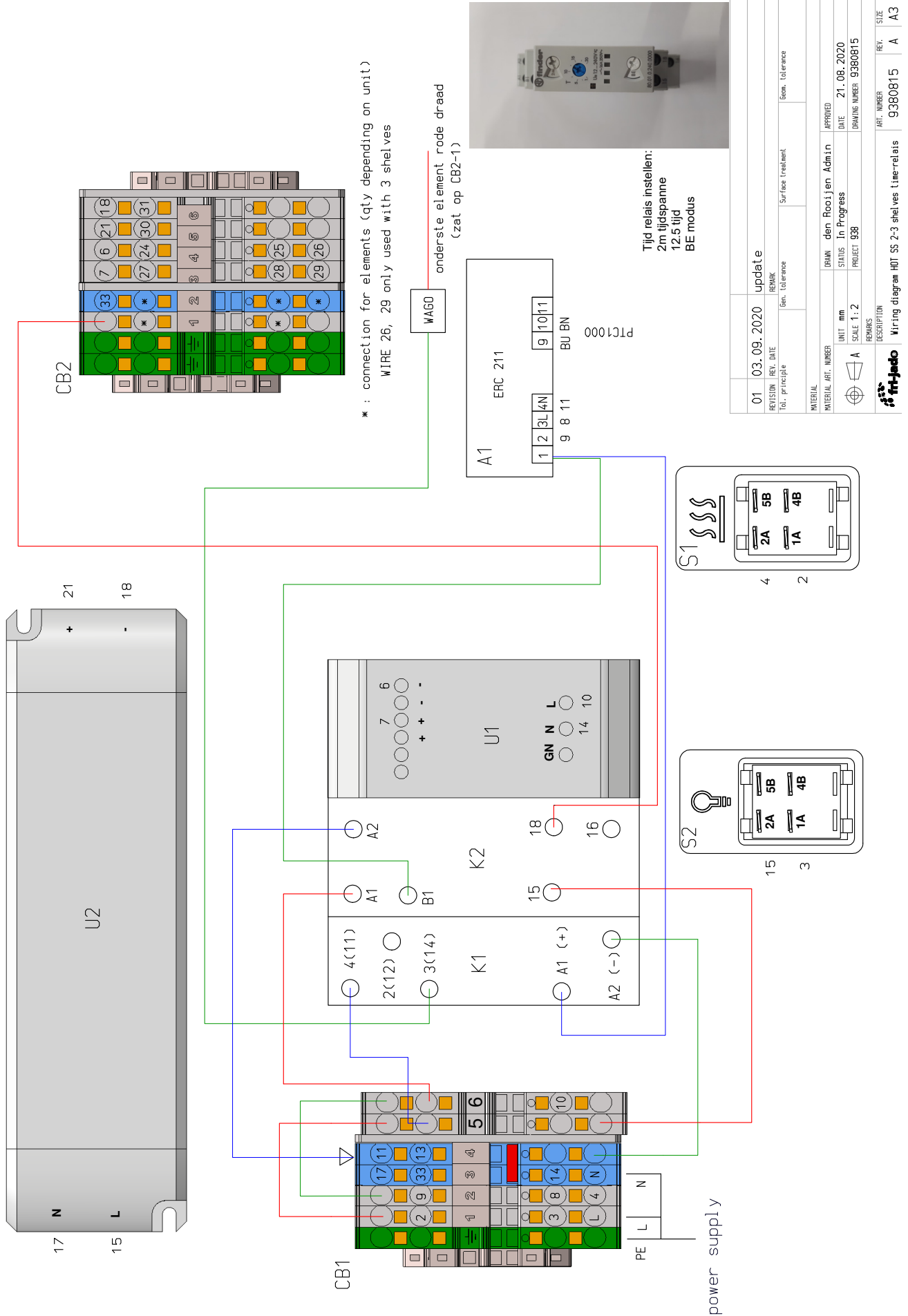

15.2.1 Electrical schematic MCC Hot (Self Serve, Three phase)

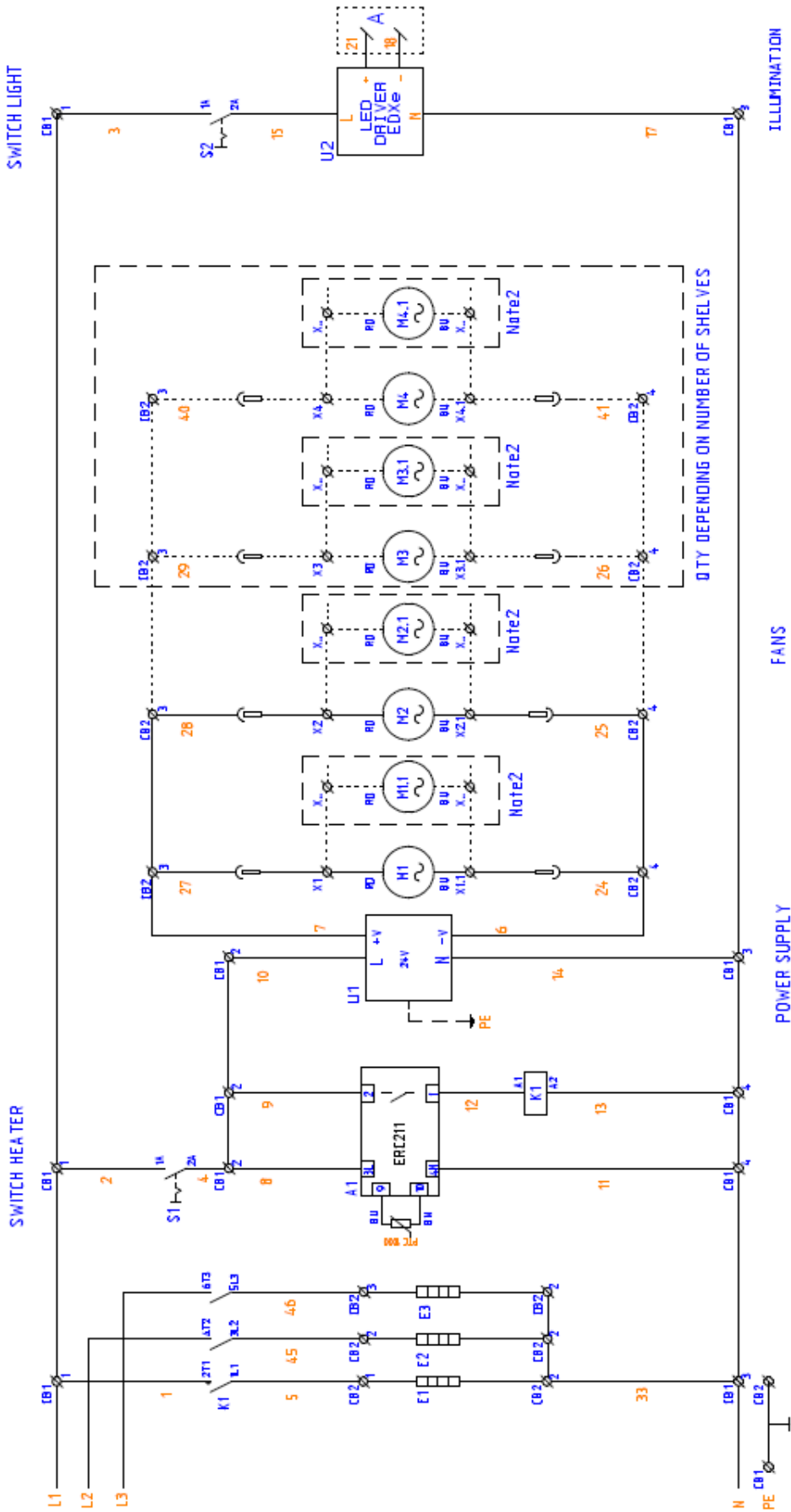

E1	top shelf	935W
E2	middle shelf	1130W
E3	bottom shelf	1500W

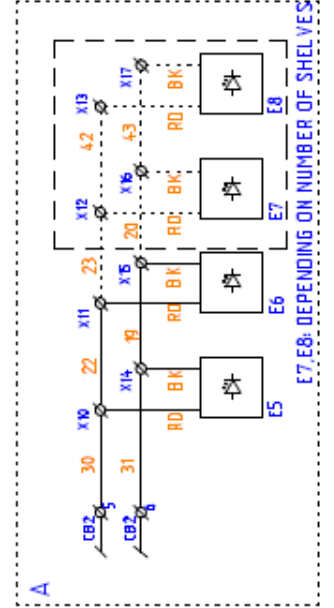
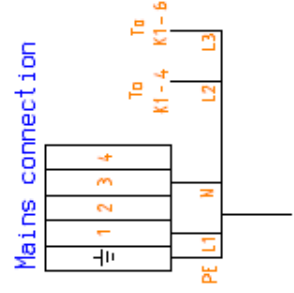

- BH - BROWN
- BU - BLUE
- GN - GREEN
- RD - RED
- YE - YELLOW
- BK - BLACK
- OR - ORANGE

01	11.11.2020	element table
REVISION	REV. DATE	REVISION
1	11.11.2020	1
DRAWN: den Rooijen Adelin STATUS: In Progress DATE: 17.08.2020 PROJECT: 9380813 SCALE: 1:1 SHEETS: 4 SHEET NUMBER: 9380813		
REVISION: 9380813 REV. DATE: 17.08.2020 REV. BY: A.3		

Note1: QTY DEPENDING ON WIDTH OF THE UNIT
 Note2: QTY DEPENDING ON NUMBER OF SHELVES

15.2.2 Electrical wiring MCC Hot (Self Serve, Three phase)

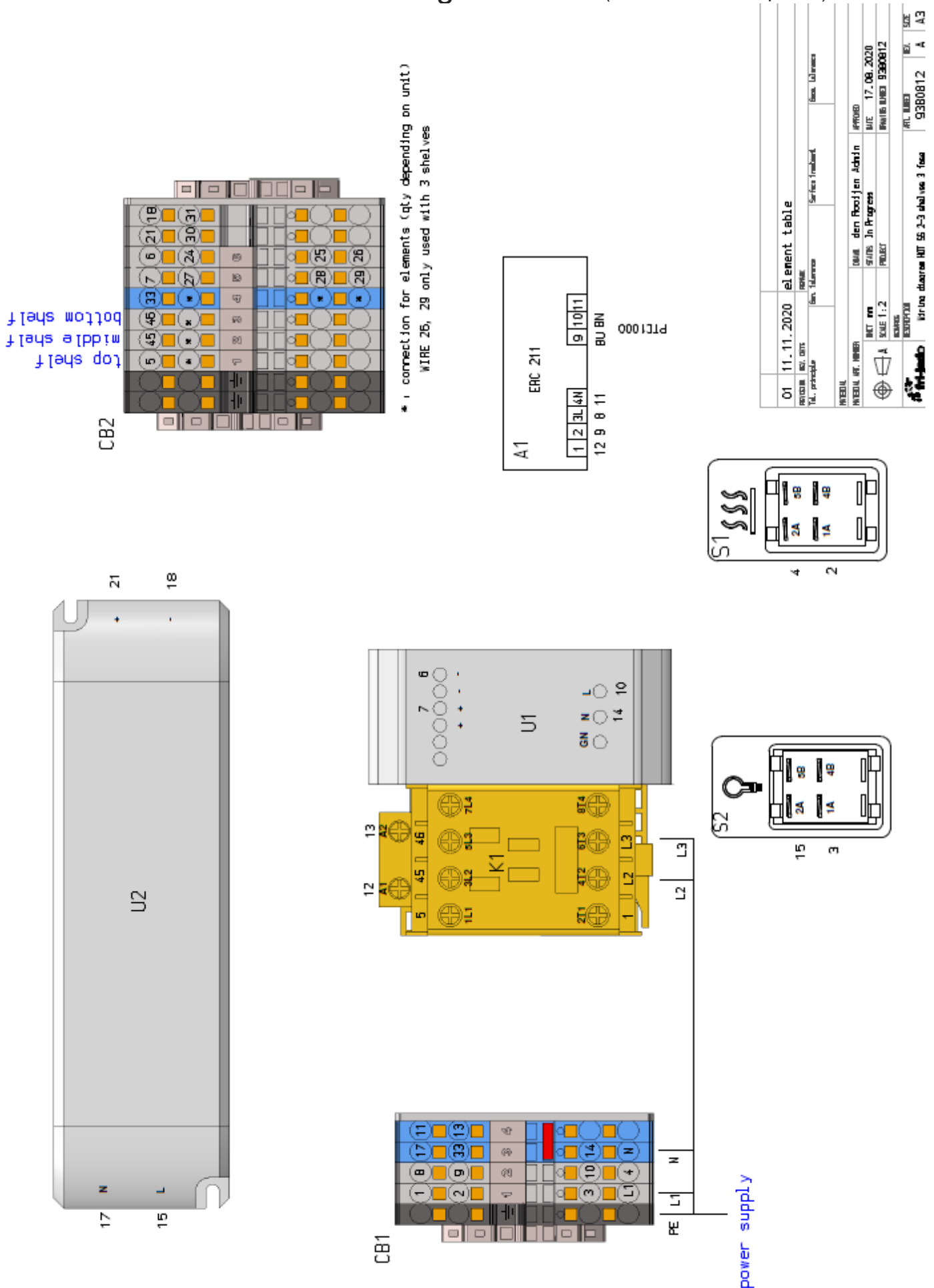

REV	DATE	DESCRIPTION	BY	CHK
01	11.11.2020	element table		

NO	REV	DATE	DESCRIPTION	BY	CHK
1	1	17.08.2020	Wiring diagram HT 55 2-3 shelves 3 fase		

15.2.3 Electrical wiring MCC Hot (Self Serve, Three phase)

Schematics started production week 42 2021

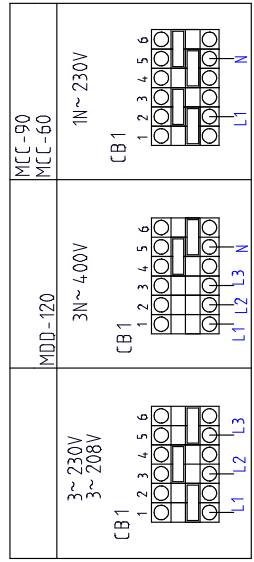
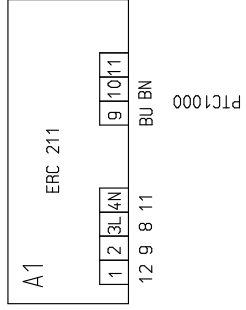
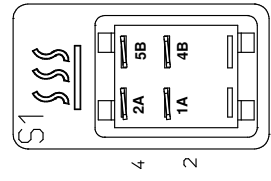
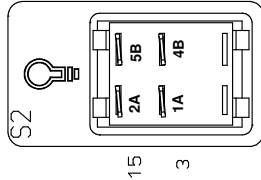
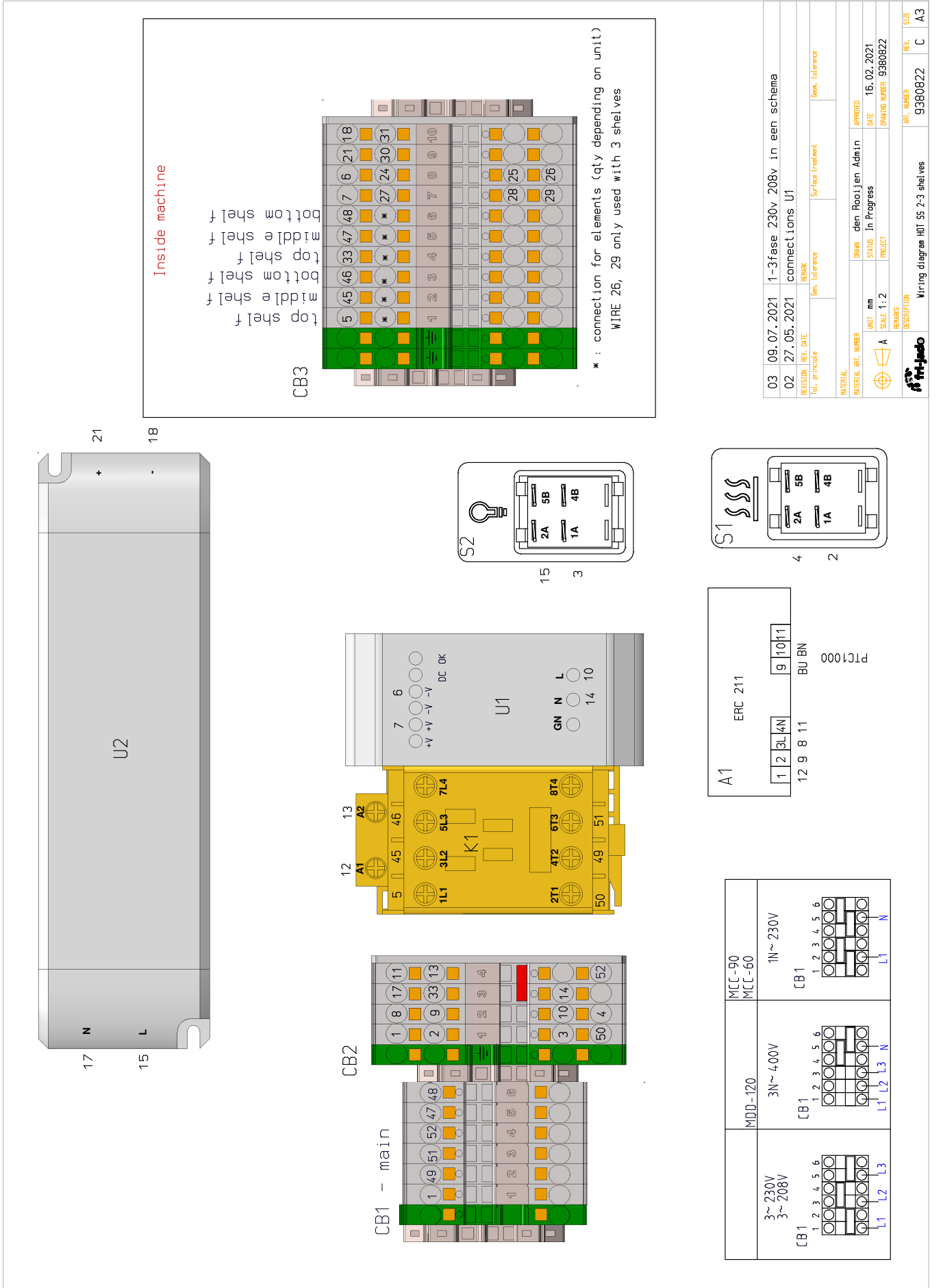

03	09.07.2021	1-3fase 230v 208v in een schema			
02	27.05.2021	connections U1			
REF. PRINCIPLE	REV. DATE	REMARK	San. Tolerance	Surface treatment	San. Tolerance
MATERIAL	MATERIAL ART. NUMBER	BRAND	den Rooijen Admin	APPROVED	
UNIT	mm	STATUS	In Progress	DATE	16.02.2021
SCALE	1:2	PROJECT		DRAWING NUMBER	9380822
REMARKS		DESCRIPTION	Wiring diagram HOT SS 7-3 shelves	ART. NUMBER	9380822
				REV.	C
				SIZE	A3

Empty page

15.3 Circuit Diagram MCC Hot (Full Serve first version)

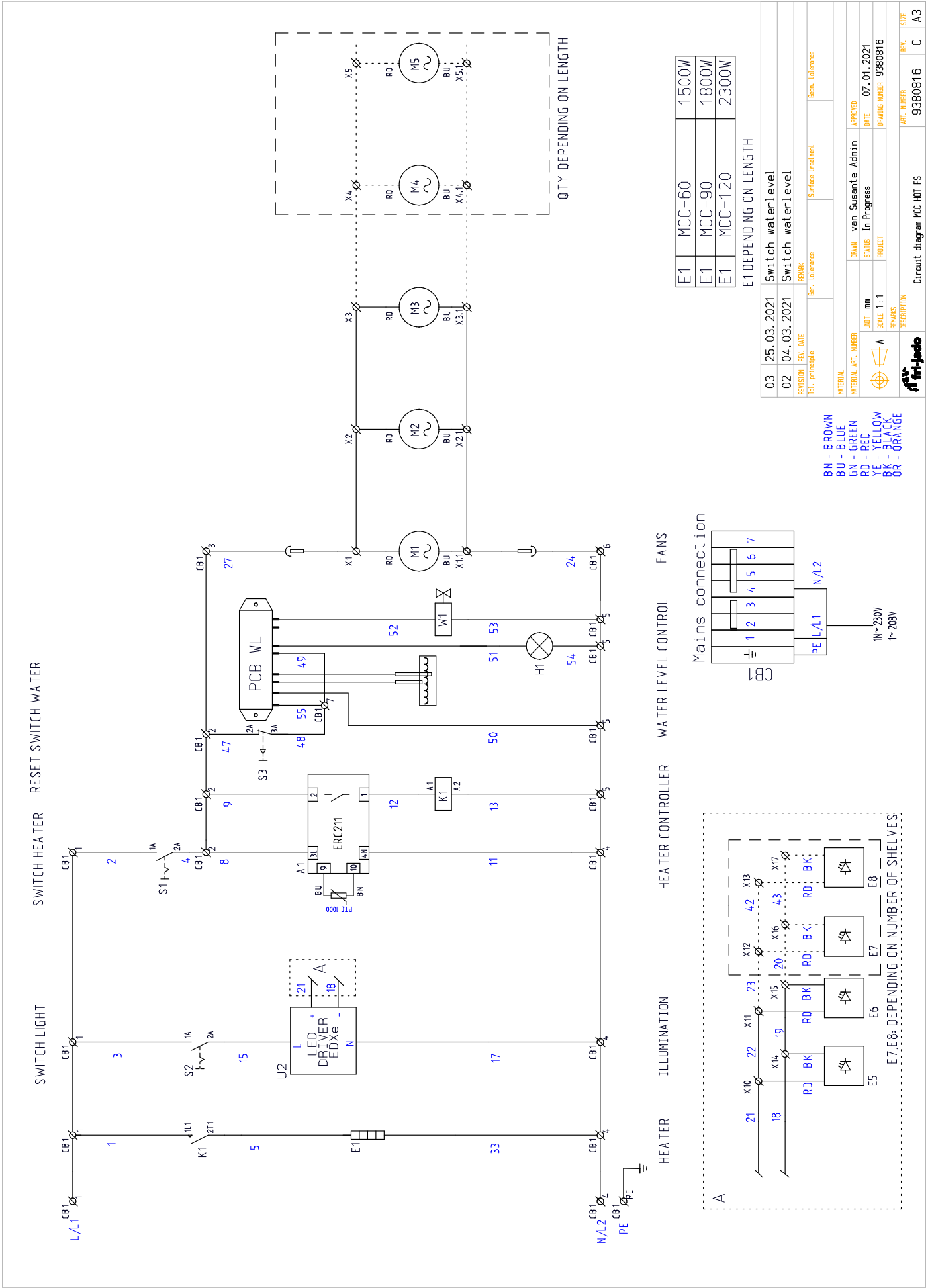

E1	MCC-60	1500W
E1	MCC-90	1800W
E1	MCC-120	2300W

E1 DEPENDING ON LENGTH

03	25.03.2021	Switch water level	REVISION	REL. DATE	REL. DATE	REMARK																																				
02	04.03.2021	Switch water level	01 - principle	02 - tolerance	03 - Surface treatment	04 - tolerance																																				
<table border="1"> <tr> <td>MATERIAL</td> <td>MATERIAL ART. NUMBER</td> <td>DRAWN</td> <td>van Susente Admin</td> <td>APPROVED</td> <td></td> </tr> <tr> <td></td> <td></td> <td>STATUS</td> <td>In Progress</td> <td>DATE</td> <td>07.01.2021</td> </tr> <tr> <td></td> <td></td> <td>SCALE</td> <td>1:1</td> <td>PROJECT</td> <td>DRAWING NUMBER 9360816</td> </tr> <tr> <td colspan="2">REMARKS</td> <td colspan="4">DESCRIPTION</td> </tr> <tr> <td colspan="2">fri-jado</td> <td colspan="4">Circuit diagram MCC HOT FS</td> </tr> <tr> <td>ART. NUMBER</td> <td>9360816</td> <td>REV.</td> <td>C</td> <td>SIZE</td> <td>A3</td> </tr> </table>							MATERIAL	MATERIAL ART. NUMBER	DRAWN	van Susente Admin	APPROVED				STATUS	In Progress	DATE	07.01.2021			SCALE	1:1	PROJECT	DRAWING NUMBER 9360816	REMARKS		DESCRIPTION				fri-jado		Circuit diagram MCC HOT FS				ART. NUMBER	9360816	REV.	C	SIZE	A3
MATERIAL	MATERIAL ART. NUMBER	DRAWN	van Susente Admin	APPROVED																																						
		STATUS	In Progress	DATE	07.01.2021																																					
		SCALE	1:1	PROJECT	DRAWING NUMBER 9360816																																					
REMARKS		DESCRIPTION																																								
fri-jado		Circuit diagram MCC HOT FS																																								
ART. NUMBER	9360816	REV.	C	SIZE	A3																																					

- BN - BROWN
- BU - BLUE
- GN - GREEN
- RD - RED
- YE - YELLOW
- BK - BLACK
- OR - ORANGE

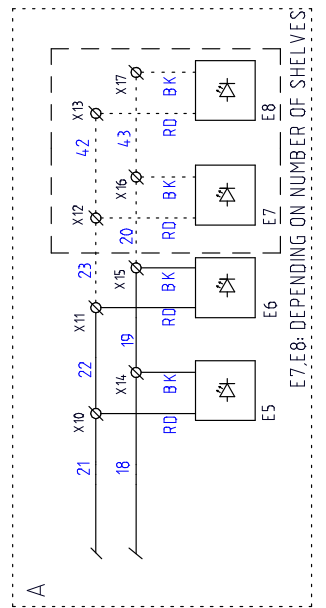
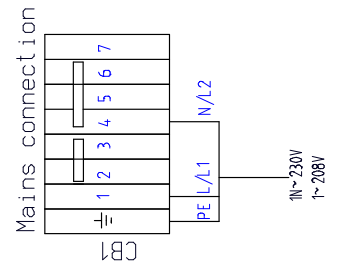

15.4 Electrical wiring MCC Hot (Full Serve first version)

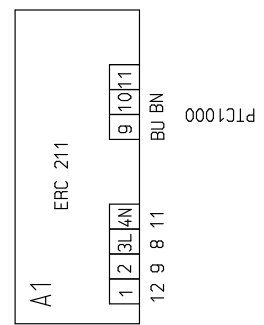
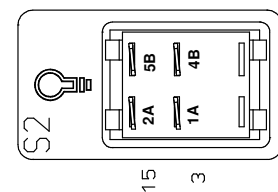
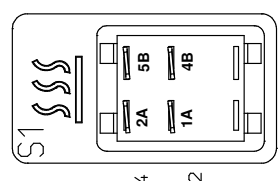
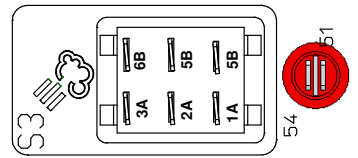
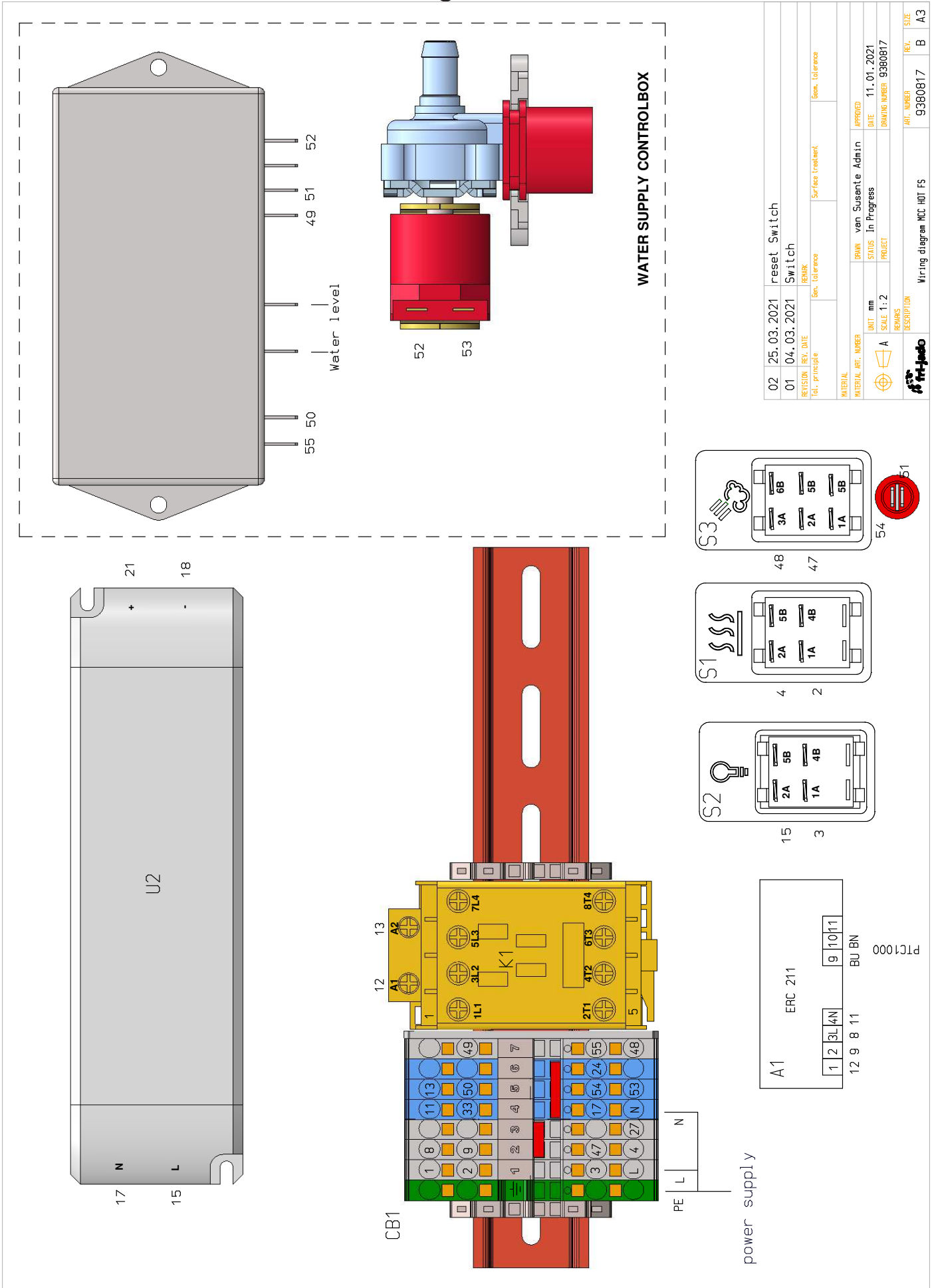

02	25.03.2021	reset Switch	APPROVED	
01	04.03.2021	Switch	STATUS	In Progress
REVISION / REV. DATE		DESIGNER	DATE	11.01.2021
/ Rev. principle		Gen. tolerance	PROJECT	DRAWING NUMBER 9380817
		Surface treatment	REVISIONS	
		Gen. tolerance	DESCRIPTION	Wiring diagram MCC HOT FS
MATERIAL ART. NUMBER		UNIT	mm	APPROVED
MATERIAL		SCALE	1:2	DATE
DRAWN		van Susante Admin	PROJECT	DRAWING NUMBER
STATUS		In Progress	REVISIONS	REV.
PROJECT		9380817	DESCRIPTION	SIZE
ART. NUMBER		9380817	REV.	B
ART. NUMBER		9380817	REV.	A3

15.5 Circuit Diagram MCC Hot (Full Serve second version)

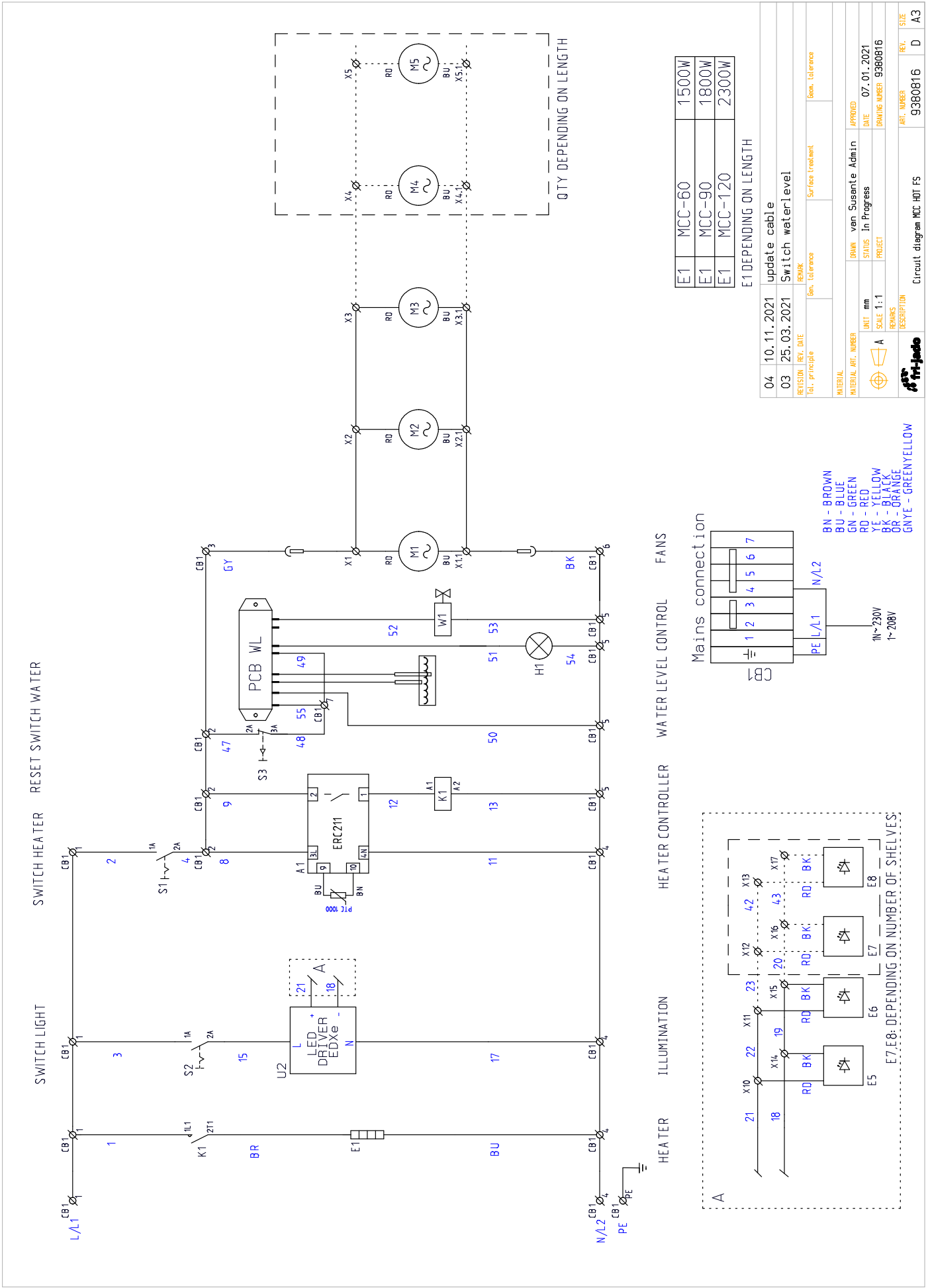

15.6 Circuit Diagram MCC Hot (Full Serve first second version)

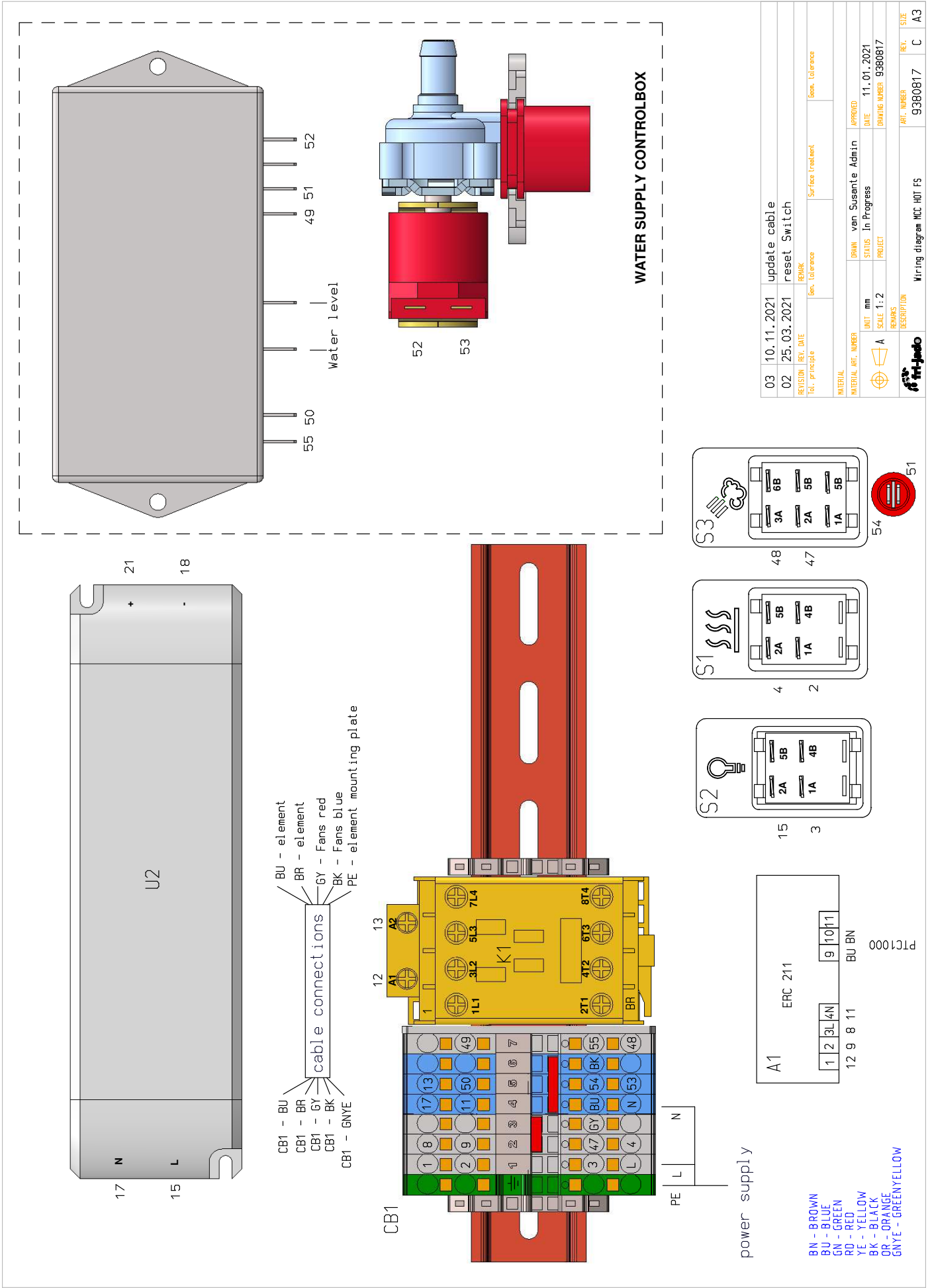



Fri-Jado B.V.
Blauwhekken 2
4751 XD Oud Gastel
The Netherlands
Tel: +31 (0) 76 50 85 400

Fri-Jado Inc.
1401 Davey Road, Suite 100
Woodridge IL 60517
USA
Tel: +1-630-633-7950